

BÉMÁCI s.r.o.

Komínové systémy



KATALOG VÝROBKŮ

PŘETLAKOVÉ SYSTÉMY



10/2023



BĚMÁCI s.r.o.

www.bemaci.cz

Sídlo a výroba:

Družstevní 423, 251 65 Ondřejov

Tel. 606 146 318, 323 649 265

Email: vyroba@bemaci.cz



Pobočka:

Vladivostocká 1460/10, 100 00 Praha Vršovice

Tel. 606 146 317, 222 522 370

Email: info@bemaci.cz



Katalog přetlakových výrobků je navržen pro snadnou orientaci v sortimentu systémů určených pro odvod spalin od spotřebičů a přívod spalovacího vzduchu.

Zatřídění komponentů je podle tabulky charakteristik, umístěné na předposlední straně. Maximální teplota spalin u plastové vložky je 120° C, nerezové až 250°C. Jednotlivé díly jsou opatřeny silikonovým těsněním, které zajistí dokonalé spojení výrobků.

Protože preferujeme vlastní výrobu, je po dohodě možné dodat i výrobky o jiných rozměrech a v jiných provedeních, než jsou vyobrazeny v katalogu.

Při navrhování systémů a jejich instalaci je nutné dodržet veškeré předpisy podle platných norem!

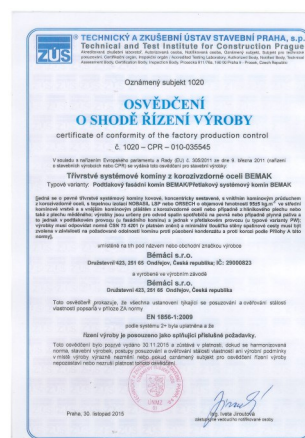

OBSAH:

Typ systémů	Teplotní třída	Materiál	Strana
Jednoduché	T120	plast	4 - 13
	T250	nerez	14 - 17
Koaxiální	T120	plast / Al, Fe	18 - 20
	T120	plast / nerez	21 - 22
	T120	Ohebné: plast / nerez, Al	23
	T250	nerez / nerez	24 - 25
Kaskádové kouřovody	T120	plast	26
	T250	nerez	27
Tříslůžkové	T120	plast / Al	28 - 29
	T120	plast / nerez	30 - 31
	T250	nerez / Al	32 - 33
	T250	nerez / nerez	34 - 35
Kotvicí prvky		ocel a nerez	36 - 38
Charakteristika podle ČSN, ukázka dalších výrobků			39

Ceny sestav rychle a snadno získáte v kalkulačce na našich stránkách!

Jednotlivé díly i celé sestavy můžete objednat v našem eshopu:

www.bemaci.cz

Ceník je pouze orientační, firma Bémáci s.r.o. si vyhrazuje právo na možné změny cen!

V případě potřeby si vyžádejte závaznou cenovou nabídku!

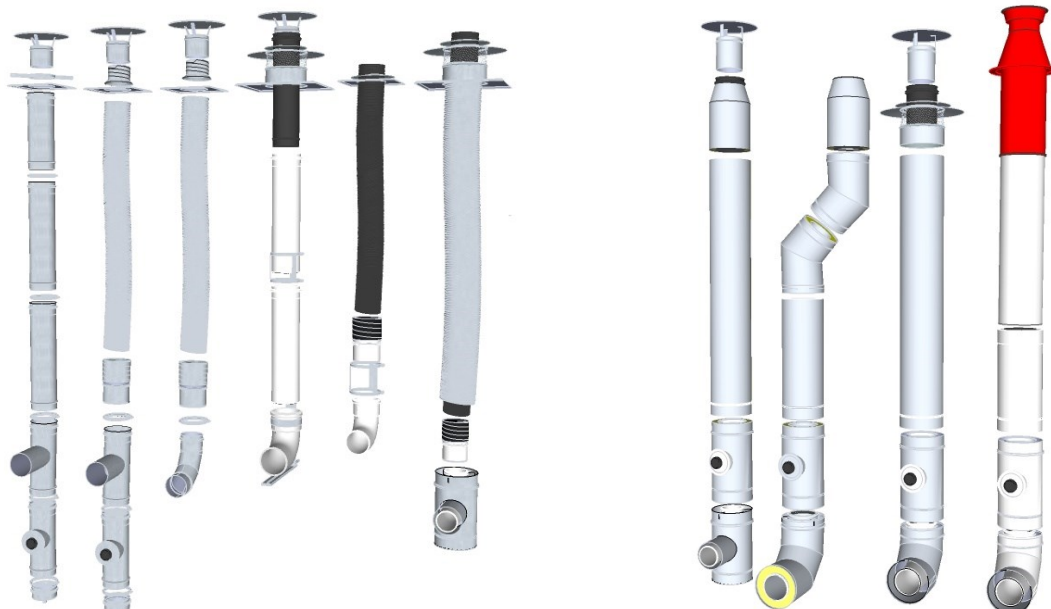

PP UV STABILNÍ



FLEX			
Průměr	Kód	Cena	Délka (m)
75	24075	393	1—30
90	24090	424	1—25
110	24110	462	1—25
125	24125	550	1—25



Přechod vrchní FLEX / Pevná		
Průměr	Kód	Cena
FLEX 75 / 80	277580	545
FLEX 90 / 110	2790110	763
110	27110	793
125	27125	757



KOLENA S PŘECHODEM ŠROUBOVACÍ pevná / flex			
Průměr	Kód	Cena	Délka vyústění
60 / F 75	F10060BS	1331	60 mm
80 / F 75	F10080BS	648	60mm
80 / F 75	F10080BS2	708	490mm
80 / F 75	F10080PBS	769	60mm s patkou
80 / F 75	F10080PBS2	914	490 mm s patkou
80 / F 90	F9010080BS	793	60mm
80 / F 90	F9010080PBS	823	60mm s patkou
80 / F 90	F9010080PBS2	914	490mm s patkou



Přechod spodní Pevná / FLEX		
Průměr	Kód	Cena
80 / F 75	268075	520
80 / F 90	268090	666
100 / F 110	26100110	793
110	26110	738
125	26125	926



Spojka FLEX		
Průměr	Kód	Cena
75	23075	629
90	23090	854
90 / 110	2390110	938
110	23110	926
125	23125	1 113



KRYCÍ SUKÝNKY - Nerezové		
Průměr	Kód	Cena
60	PNSU060	227
80	PNSU080	237
100	PNSU100	255
110	PNSU110	262
125	PNSU125	266

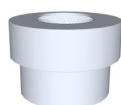

Nerez Horní uslepení s přísávaním		
Průměr	Kód	Cena
60/100	NHUSP100	686
80/125	NHUSP125	851
80/130	NHUSP130	867
80/150	NHUSP150	884
80/180	NHUSP180	1 386
80/200	NHUSP200	1 428
110/250	NHUSP250	1 571

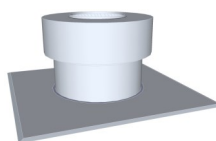

Nerez Horní uslepení s přísávaním s plechem		
Průměr	Kód	Cena
60/100	NHUSP100P	1 023
80/125	NHUSP125P	1 135
80/130	NHUSP130P	1 142
80/150	NHUSP150P	1 254
80/180	NHUSP180P	1 650
80/200	NHUSP200P	1 709
110/250	NHUSP250P	1 789

PP UV STABILNÍ



ROURA FLEXIBILNÍ

Průměr	Kód	Cena	Délka (m)
60	P210060F	327	1—85
80	P210080F	393	1—50
100	P210100F	678	1—50
110	P210110F	847	1—20
125	P210125F	1 331	1—30
160	P210160F	1 839	1—30



Montážní set

Průměr	Kód	Cena
60	P200060F	611
80	P200080F	653
100	P200100F	738
110	P200110F	968
125	P200125F	2 783
160	P200160F	3 400

Komínový poklop

Průměr	Kód	Cena
60	P417060	1 150
80	P417080	1 271
100	P417100	1 561
110	P417110	1 815
125	P417125	2 408
160	P417160	3 158
200	P417200	4 029
250	P417250	5 385

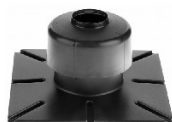

Revizní díl

Průměr	Kód	Cena
60	P202060FR	1 295
80	P202080FR	1 688
100	P202100FR	2 051
110	P202110FR	2 154
125	P202125FR	4 126
160	P202160FR	4 725



Spojka

Průměr	Kód	Cena
60	P215060F	690
80	P215080F	1 041
100	P215100F	1 331
110	P215110F	1 519
125	P215125F	2 353
160	P215160F	2 789

Včetně trnu a spon

ZPĚTNÁ KLAPKA DO TRUBKY

80	Kód	P200080KL
	Cena	1526



ROURY REVIZNÍ

Průměr	Kód	Cena
60	P202060R	315
80	P202080R	405
100	P202100R	557
110	P202110R	906
125	P202125R	1 392
160	P202160R	2 390
200	P202200R	2 408
250	P202250R	4 961



ROURY S MĚŘÍCÍM OTVOREM

Průměr	Kód	Cena
60	P202060M	490
80	P202080M	417
100	P202100M	575
110	P202110M	871
125	P202125M	1 083
160	P202160M	1 464
200	P202200M	1 997
250	P202250M	2 541



ZACHYT. KONDENZÁTU

Průměr	Kód	Cena
60	P217060	653
80	P217080	593
100	P217100	841
110	P217110	1 452
125	P217125	1 561
160	P217160	1 930
200	P217200	2 965
250	P217250	4 211



Včetně sifonu



TRUBKY 250 mm		
Průměr	Kód	Cena
60	20060B	121
80	20080B	157
100	20100B	230
110	20110B	218
125	20125B	285
160	20160B	285
200	20200B	745
250	20250B	2160

TRUBKY 500 mm		
Průměr	Kód	Cena
60	21060B	164
80	21080B	188
100	21100B	254
110	21110B	218
125	21125B	321
160	21160B	472
200	21200B	1101
250	21250T	2753
315	21315Š	4230

TRUBKY 1 000 mm		
Průměr	Kód	Cena
60	22060B	218
80	22080B	254
100	22100B	418
110	22110B	394
125	22125B	527
160	22160B	708
200	22200B	1701
250	22250B	3787
315	22315Š	6577

TRUBKY 2 000 mm		
Průměr	Kód	Cena
60	19060B	394
80	19080B	442
100	19100B	660
110	19110B	605
125	19125B	835
160	19160B	1180
200	19200B	3032
250	19250B	5778
315	19315Š	11023

TRUBKY 330 mm		
Průměr	Kód	Cena
80	20080B3	174

PP UV STABILNÍ



TRUBKY 315 mm		
Průměr	Kód	Cena
60	P202060	123
80	P202080	133
100	P202100	230
110	P202110	339
125	P202125	442
160	P202160	690
200	P202200	835
250	P202250	1 827

TRUBKY 560 mm		
Průměr	Kód	Cena
60	P205060	157
80	21080C	224
100	P205100	309
110	P205110	411
125	P205125	617
160	P205160	835
200	P205200	1 404
250	P205250	2 287

TRUBKY 1 015 mm		
Průměr	Kód	Cena
60	P210060	231
80	22080C	347
100	22100C	600
110	22110C	559
125	22125C	752
160	22160C	1019
200	P210200	1809
250	P210250	3 467

TRUBKY 2 015 mm		
Průměr	Kód	Cena
60	P220060	398
80	19080C	502
100	P220100	768
110	P220110	1 107
125	P220125	1 464
160	P220160	1 912
200	P220180	3 134
250	P220250	4 816

SPOJKY TRUBEK		
Průměr	Kód	Cena
60	39060B	351
80	39080B	438
100	39100B	605
110	39110B	454
125	39125B	508
160	39160B	563



TĚSNĚNÍ		
Průměr	Kód	Cena
60	31060	48
80	31080	55
100	31100	55
110	31110	55
125	31125	121
160	31160	121



Pojistné objímky dvojité — nerez		
Průměr	Kód	Cena
60	NPOD060	190
80	NPOD080	231
100	NPOD100	252
110	NPOD110	260
125	NPOD125	268
160	NPOD160	276
200	NPOD200	287





KOLENA 87°		
Průměr	Kód	Cena
60	10060B	157
80	10080B	128
100	10100B	206
110	10110B	188
125	10125B	363
160	10160B	496
200	10200B	1894
250	10250T	7732
315	10315Š	15839



KOLENA 45°		
Průměr	Kód	Cena
60	11060B	157
80	11080B	128
100	11100B	309
110	11110B	176
125	11125B	363
160	11160B	496
200	11200B	2166
250	11250T	6577
315	11315Š	14079



KOLENA 30°		
Průměr	Kód	Cena
80	11080B/30	182
100	11100B/30	327
110	11110B/30	249
125	11125B/30	394
160	11160B/30	854
200	11200B/30	2202
250	11250T/30	6504
315	11315Š/30	12990



KOLENA 87° REVIZNÍ		
Průměr	Kód	Cena
60	12060B2	641
80	12080B2	612
100	12100B	672
110	12110B	696
125	12125B	1525
160	12160B	2045
200	12200B	2148
250	12250T	9680
315	12315Š	18484



KOLENA 45° REVIZNÍ		
Průměr	Kód	Cena
80	43080B	914
110	43110B	1047
125	43125B	1519
160	43160B	2245

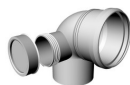

KOLENA 87° REVIZNÍ PRAVÉ		
Průměr	Kód	Cena
80	14080B	690
110	14110T	1077
125	14125T	1525
160	14160T	2245



KOLENA 87° REVIZNÍ LEVÉ		
Průměr	Kód	Cena
80	13080B	690
110	13110T	1077
125	13125T	1525
160	13160T	2245



KOLENO REDUKOVANÉ		
Průměr	Kód	Cena
60 / 80	1006080B	424



KOLENA 45° REVIZNÍ PRAVÉ		
Průměr	Kód	Cena
110	51110T	1047
125	51125T	1525
160	51160T	2245



KOLENA 45° REVIZNÍ LEVÉ		
Průměr	Kód	Cena
110	50110T	1047
125	50125T	1 525
160	50160T	2 245



KOLENA ŠROUBOVACÍ 6 CM		
Průměr	Kód	Cena
60	10060BS	551
80	10080BS	424



KOLENA ŠROUBOVACÍ 50 CM		
Průměr	Kód	Cena
60	10060BS2	593
80	10080BS2	484

PP UV STABILNÍ



KOLENA 87°

Průměr	Kód	Cena
60	P290060	169
80	P290080	187
100	P290100	315
110	P290110	502
125	P290125	750
160	P290160	1 325
200	P290200	2 541
250	P290250	4 707

KOLENA 45°

Průměr	Kód	Cena
60	P245060	157
80	P245080	163
100	P245100	278
110	P245110	513
125	P245125	782
160	P245160	1 234
200	P245200	2 214
250	P245250	3 636

KOLENA 30°

Průměr	Kód	Cena
60	P230060	157
80	P230080	163
100	P230100	436
110	P230110	466
125	P230125	714
160	P230160	1 234
200	P230200	2 214
250	P230250	3 279

KOLENA 87° REVIZNÍ

Průměr	Kód	Cena
60	P291060	339
80	P291080	436
100	P291100	605
110	P291110	1 198
125	P291125	1 924
160	P291160	2 287
200	P291200	3 207
250	P291250	5 385

KOLENA PATNÍ

ŠROUBOVACÍ



Průměr	Kód	Cena
60	P292060	992
80	P292080	992
100	P292100	1 416
110	P292110	1 658



KOLENA PATNÍ

Průměr	Kód	Cena
60	P293060	545
80	P293080	787
100	P293100	1 077
110	P293110	1 343
125	P293125	1 918
160	P293160	2 783
200	P293200	3 073
250	P293250	6 837

KONZOLE S OBJÍMKOU



Průměr	Kód	Cena
60	NKONZO060	386
80	NKONZO080	386
100	NKONZO100	406



KOLENA S KONZOLÍ

80	Kód	P190BKZ
	Cena	648
80 / 60	Kód	P190ABKZ
	Cena	772



450

KOLENA S PODPĚROU

Průměr	Kód	Cena
80	10080PB	315
100	10100PB	394
110	10110PB	375
125	10125PB	551
160	10160PB	684
200	10200PB	2366



KOLENA S PODPĚROU

ŠROUBOVACÍ 6 cm

Průměr	Kód	Cena
80	10080PBS	612

KOLENA S PODPĚROU

ŠROUBOVACÍ 50 cm

Průměr	Kód	Cena
80	10080PBS2	672
60/80	1006080PBS	968



T KUSY

Průměr	Kód	Cena
60	25060B	254
80	25080B	333
100	25100B	527
110	25110B	430
125	25125B	1313
160	25160B	1991
200	25200B	1858
250	25250B	5578

T KUSY REVIZNÍ

Průměr	Kód	Cena
80	53080B	575
100	53100B	1004
110	53110B	605
125	53125B	1120
160	53160B	2190

REVIZNÍ DÍLY

Průměr	Kód	Cena
80	16080B	472
100	16100B	817
110	16110B	436
125	16125B	1065
160	16160B	1725
200	16200B	1 791
250	16250T	6988
315	16315Š	18483

T KUSY REVIZNÍ

VRTIKÁLNÍ

Průměr	Kód	Cena
80	17080B	739
100	17100B	703
110	17110B	902
125	17125B	1725
160	17160B	2499



T KUSY S REVIZNÍM

S ODTOKEM

Průměr	Kód	Cena
80	18080B	738
100	18100B	793
110	18110B	902
125	18125B	1725
160	18160B	2263

T KUSY ŠROUBOVACÍ

S ODTOKEM

Průměr	Kód	Cena
80	16080OH	660
100	16100OH	696
110	16110OH	696
125	16125OH	1 301
160	16160OH	1834

T KUSY ŠROUBOVACÍ

49 CM

Průměr	Kód	Cena
80	25080BS	629

ZÁTKY S TĚSNĚNÍM

Průměr	Kód	Cena
80	44080B	290



ZÁTKY

Průměr	Kód	Cena
110	44110B	116
125	44125B	206
160	44160B	375



REDUKCE		
Průměr	Kód	Cena
60 / 80	P580AR	210
60 / 100	3660100	563
60 / 110	3660110	721
60 / 125	3660125	926
60 / 160	3660160	1047
75 / 80	367580	605
80 / 100	3680100	708
80 / 110	3680110	762
80 / 125	3680125	968
80 / 160	3680160	1096
100 / 110	36100110	817
100 / 125	36100125	1004
100 / 160	36100160	1 108
110 / 125	36110125	1004
110 / 160	36110160	1137
125 / 160	36125160	1168
125 / 200	36125200	2100
125 / 250	36125250	5082
160 / 200	36160200	2100
160 / 250	36160250	4689
200 / 250	36200250	4795

ADAPTÉRY		
Průměr	Kód	Cena
80 / 60	368080	551
100 / 80	3610080	762
110 / 80	3611080	762
110 / 100	36110100	793
125 / 80	3612580	920
125 / 100	36125100	1057
125 / 110	36125110	1 168
140 / 125	36140125	992
200 / 160	36200160	2989
250 / 160	36250160	2402
250 / 200	36250200	3117

REDUKCE EXCENTRICKÉ		
Průměr	Kód	Cena
80 / 60	P581AR	210
110 / 80	P548GR	817
110 / 100	P584CGR	882
125 / 80	P584BDR	817
125 / 100	P584CDR	882
125 / 110	P584GDR	882
160 / 110	P584GHR	1 176
160 / 125	P584DHR	1 210
200 / 125	P584DNR	1 998
200 / 160	P584HNR	2 063

PP UV STABILNÍ



REDUKCE		
Průměr	Kód	Cena
60 / 80	P284060080C	375
80 / 100	P284080100C	472
80 / 110	P284080110C	780
80 / 125	P284080125C	1 730
100 / 110	P284100110C	749
100 / 125	P284100125C	1 059
100 / 160	P284100160C	1 209
110 / 125	P284110125C	1 555
125 / 160	P284125160C	1 162

ADAPTÉRY		
Průměr	Kód	Cena
80 / 60	P285080060C	472
110 / 80	P285110080C	508
110 / 100	P285110100C	563
125 / 100	P285125100C	1 157
150 / 100	P285150100C	2 116
125 / 110	P285125110C	974
130 / 125	P285130125C	1 646
150 / 125	P285150125C	1 797
160 / 125	P285160125C	1 392
180 / 160	P285180160C	2 287
200 / 160	P285200160C	2 662
250 / 200	P285250200C	2 783

REDUKCE EXCENTRICKÉ		
Průměr	Kód	Cena
60 / 80	P283060080E	507
80 / 100	P283080100E	604
80 / 110	P283080110E	1 029
80 / 125	P283080125E	1 272
100 / 110	P283100110E	1 076
100 / 125	P283100125E	1 137
100 / 160	P283100160E	2 130
110 / 125	P283110125E	797
110 / 160	P283110160E	1 857
125 / 160	P283125160E	1 857
125 / 200	P283125200E	2 021
130 / 160	P283130160E	1 682
150 / 160	P283150160E	2 212
160 / 200	P283160200E	1 688
180 / 200	P283180200E	2 366
200 / 250	P283202250E	3 134



ROZDĚLOVAČE		
Rozdělovač 60/100 na 2x 80	Kód	PA422TTO
	Cena	866
Rozdělovač 80/125 na 2x 80	Kód	PA422ET
	Cena	932



ADAPTÉRY SE ZPĚTNOU KLAPKOU		
110 / 80	Kód	4211080
	Cena	2596
125 / 80	Kód	4212580
	Cena	3407
160 / 80	Kód	42110160
	Cena	3746



ZACHYTÁVAČE KONDENZÁTU HORIZONTÁLNÍ		
Průměr	Kód	Cena
80	55080B	249
100	55100B	273
125	55125B	290
160	55160B	351

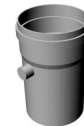

ZACHYTÁVAČE KONDENZÁTU VERTIKÁLNÍ		
Průměr	Kód	Cena
80	56080B	581
100	56100B	621
125	56125B	639
160	56160B	721



VÍČKA S ODTOKEM		
Průměr	Kód	Cena
60	28060B	442
80	28080B	430
100	28100B	527
110	28110B	527
125	28125B	793
160	28160B	963
200	28200B	1283



VÍČKA		
Průměr	Kód	Cena
60	29060B	418
80	29080B	430
100	29100B	484
110	29110B	484
125	29125B	549
160	29160B	926

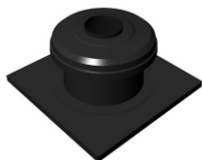

UKONČOVACÍ KRYTY KOMÍNŮ

s možností přisávání nebo odvětrání

Průměr	Kód	Cena
80	ZB80SCHA	1 670
100	ZB100SCHA	2 042



PRŮCHODY STŘECHOU 25° - 50°

červený / černý

Průměr	Kód	Cena
125	ZB125UBPR	845
125	ZB125UBPS	845

HLAVICE PRO PŘISÁVÁNÍ

VZDUCHU - NEREZ

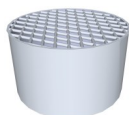

Průměr	Kód	Cena
80	5NV080S	165
100	5NV100S	178
125	5NV125S	211

Lze dodat i jiné rozměry.



HLAVICE PRO PŘISÁVÁNÍ

VZDUCHU—PLAST

Průměr	Kód	Cena
80	TERM08P	138

HLAVICE PRO PŘISÁVÁNÍ

VZDUCHU - NEREZ 45°

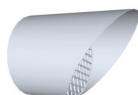

Průměr	Kód	Cena
80	5NV080S45	314
100	5NV100S45	339
125	5NV125S45	405

Lze dodat i jiné rozměry.



KRYCÍ MANŽETY - NEREZ

Průměr	Kód	Cena
60	PNSU060	227
80	PNSU080	237
100	PNSU100	255
125	PNSU125	266

Lze dodat i jiné rozměry.

KRYCÍ MANŽETY - SILIKON

Průměr	Kód	Cena
80	830BG	95
100	830CG	110
125	830DG	278



KRYCÍ MANŽETY - NEREZ BÍLÁ

Průměr	Kód	Cena
60	PNSU060B	279
80	PNSU080B	289
100	PNSU100B	308
125	PNSU125B	319



Lze dodat i jiné rozměry.



STŘEDÍCÍ OBJÍMKY

Průměr	Kód	Cena
80	NSO080	200
110	NSO100	218
125	NSO125	239
160	NSO160	271

Lze dodat i jiné rozměry.

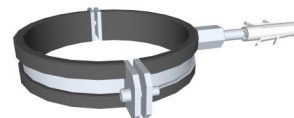

KOTVÍCÍ PRVKY

Průměr	Kód	Cena
60	32060	58
80	32080	65
110	32110	75
125	32125	90
160	32160	135

Další kotvící prvky viz. strany 36 - 38.



SILIKONOVÁ PASTA 150 ml

Kód	Cena
833SIP	150



MONTÁŽNÍ HLAVY

S OBJÍMKOU

Průměr	Kód	Cena
75	NNH750	708



MONTÁŽNÍ HLAVY

S POJISTKOU

Průměr	Kód	Cena
75	NNH75	410
90	NNH90	415
110	NNH110	422
125	NNH125	460
140	NNH140	473
160	NNH160	510
200	NNH200	537

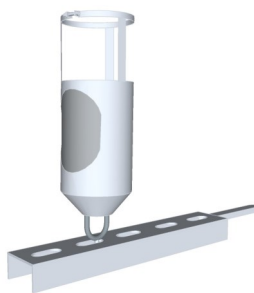

MONTÁŽNÍ HLAVY

S OBJÍMKOU A KONZOLÍ

Průměr	Kód	Cena
75	NNH750K	924



ZATLOUKACÍ KONZOLE - NEREZ

Délka (mm)	250	400
Kód	NKONZ	NKONZV2
Cena	238	285

FLEX							Délka	
Průměr	2 x 012		012		Montážní hlavy			
	Kód	Cena	Kód	Cena	Kód	Cena	Až 30 m	
60	F2060	556						
80	F2080	506	F012080	323	FMH080	432		
100	F2100	632	F012100	400	FMH100	448		
110	F2110	696	F012110	441	FMH110	465		
120	F2120	758	F012120	481	FMH120	496		
125	F2125	792	F012125	503	FMH125	505		
130	F2130	822	F012130	523	FMH130	513		
140	F2140	885	F012140	563	FMH140	520		
150	F2150	949	F012150	603	FMH150	530		
160	F2160	1011	F012160	641	FMH160	561		
180	F2180	1139	F012180	720	FMH180	576		
200	F2200	1264	F200	800	FMH200	590		
220	F2220	1390	F220	881	FMH220	605		
250	F2250	1581	F250	998				
300	F2300	1896						
350	F2350	2213						



Průměr	Přechody z hadice		Přechody do hadice		Spojky		Matice		Krycí plechy	
	Kód	Cena	Kód	Cena	Kód	Cena	Kód	Cena	Kód	Cena
60	FNP060	268	FNPDH060	618	FS060	475	FM060	135	PNKP060	543
80	FNP080	278	FNPDH080	600	FS080	475	FM080	145	PNKP080	543
100	FNP100	283	FNPDH100	690	FS100	520	FM100	155	PNKP100	543
110	FNP110	309	FNPDH110	739	FS110	558	FM110	166	PNKP110	543
120	FNP120	319	FNPDH120	786	FS120	594	FM120	176	PNKP120	543
125	FNP125	334	FNPDH125	841	FS125	633	FM125	183	PNKP125	543
130	FNP130	341	FNPDH130	860	FS130	652	FM130	190	PNKP130	543
140	FNP140	353	FNPDH140	907	FS140	690	FM140	204	PNKP140	570
150	FNP150	360	FNPDH150	963	FS150	735	FM150	220	PNKP150	570
160	FNP160	386	FNPDH160	1029	FS160	790	FM160	234	PNKP160	570
180	FNP180	426	FNPDH180	1126	FS180	852	FM180	264	PNKP180	641
200	FNP200	446	FNPDH200	1218	FS200	921	FM200	293	PNKP200	641
220	FNP220	482	FNPDH220	1311	FS220	991	FM220	323	PNKP220	
250	FNP250	502	FNPDH250	1418	FS250	1020	FM250	367	PNKP250	
300	FNP300	581	FNPDH300	1536	FS300	1392	FM300	440	PNKP300	
350	FNP350	731		1732	FS350	1740	FM350	513	PNKP350	

Podle rozměru

Možnost spojování

objímkami



TRUBKY									POJISTNÉ	
Délka	1 m		0,5 m		0,33 m		0,25 m		OBJÍMKY	
Průměr	Kód	Cena	Kód	Cena	Kód	Cena	Kód	Cena	Kód	Cena
60	VNR6060P	710	VNR6060P5	498	VNR6060P3	406	VNR6060P25	364	FPO060	110
80	PNR080	672	PNR0805	430	PNR08033	321	PNR08025	268	NPO080	169
100	PNR100	783	PNR1005	506	PNR10033	378	PNR10025	319	NPO100	179
110	PNR110	838	PNR1105	543	PNR11033	430	PNR11025	362	NPO110	181
120	PNR120	893	PNR1205	581	PNR12033	437	PNR12025	370	NPO120	184
125	PNR125	922	PNR1255	600	PNR12533	451	PNR12525	382	NPO125	186
130	PNR130	949	PNR1305	618	PNR13033	466	PNR13025	395	NPO130	188
140	PNR140	1 004	PNR1405	652	PNR14033	495	PNR14025	420	NPO140	191
150	PNR150	1 060	PNR1505	693	PNR15033	524	PNR15025	444	NPO150	195
160	PNR160	1 115	PNR1605	732	PNR16033	553	PNR16025	470	NPO160	200
180	PNR180	1 227	PNR1805	805	PNR18033	613	PNR18025	521	NPO180	206
200	PNR200	1 338	PNR2005	880	PNR20033	671	PNR20025	572	NPO200	211
220	PNR220	1 448	PNR2205	956	PNR22033	728	PNR22025	623	NPO220	228
250	PNR250	1 615	PNR2505	1 068	PNR25033	817	PNR25025	699	NPO250	244
280	PNR280	1 840	PNR2805	1 180	PNR28033	904	PNR28025	774	NPO280	274
300	PNR300	1 892	PNR3005	1 255	PNR30033	963	PNR30025	825	NPO300	299

KOLENA										
Průměr	90°		90° revizní s víčkem		90° revizní s přezkou		90° patní		45°	
	Kód	Cena	Kód	Cena	Kód	Cena	Kód	Cena	Kód	Cena
60	VNK6060P	785							VNK606045P	611
80	PNK080	639	PNK080RV	1 103	PNK080KO	866	PNK080P	798	PNK08045	475
100	PNK100	734	PNK100RV	1 272	PNK100KO	963	PNK100P	892	PNK10045	550
110	PNR110	768	PNK110RV	1 410	PNK110KO	999	PNR110P	926	PNK11045	575
120	PNK120	811	PNK120RV	1 500	PNK120KO	1 044	PNK120P	969	PNK12045	602
125	PNK125	840	PNK125RV	1 543	PNK125KO	1 077	PNK125P	999	PNK12545	614
130	PNK130	871	PNK130RV	1 615	PNK130KO	1 110	PNK130P	1 030	PNK13045	625
140	PNK140	931	PNK140RV	1 734	PNK140KO	1 170	PNK140P	1 089	PNK14045	685
150	PNK150	991	PNK150RV	1 869	PNK150KO	1 235	PNK150P	1 150	PNK15045	732
160	PNK160	1 052	PNK160RV	1 994	PNK160KO	1 299	PNK160P	1 217	PNK16045	777
180	PNK180	1 203	PNK180RV	2 270	PNK180KO	1 453	PNK180P	1 368	PNK18045	913
200	PNK200	1 493	PNK200RV	2 675	PNK200KO	1 750	PNK200P	1 658	PNK20045	971
220	PNK220	1 626	PNK250RV	2 983	PNK220KO	1 889	PNK220P	1 797	PNK25045	1 009
250	PNK250	1 835	PNK250RV	3 197	PNK250KO	2 111	PNK250P	2 013	PNK25045	1 245
280	PNK280	2 107	PNK280RV	3 612	PNK280KO	2 390	PNK280P	2 284	PNK28045	1 478
300	PNK300	2 342	PNK300RV	3 947	PNK300KO	2 639	PNK300P	2 527	PNK30045	1 682



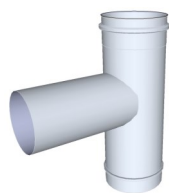

T KUSY, REVIZNÍ DÍLY, ODKAPY, KONTROLNÍ OTVORY

Délka	T kus 90°		T kus 45°		Revizní díl s víčkem		Revizní díl s přezkou		Odkap		Kontrolní otvory s přez.*		
	Průměr	Kód	Cena	Kód	Cena	Kód	Cena	Kód	Cena	Kód	Cena	Kód	Cena
60	VNT6060P	829				PNRD060	1514			VNO6060P	443		
80	PNT80	758	PNT08045	920	PNRD080	1460	PNRD080P	548	PNO080	332	PNKO080	227	
100	PNT100	837	PNT10045	1 012	PNRD100	1573	PNRD100P	607	PNO100	388	PNKO100	229	
110	PNT110	877	PNT11045	1 058	PNRD110	1586	PNRD110P	661	PNO110	416	PNKO110	231	
120	PNT120	915	PNT12045	1 103	PNRD120	1610	PNRD120P	671	PNO120	442	PNKO120	233	
125	PNT125	944	PNT12545	1 140	PNRD125	1685	PNRD125P	688	PNO125	451	PNKO125	237	
130	PNT130	975	PNT13045	1 236	PNRD130	1685	PNRD130P	705	PNO130	487	PNKO130	239	
140	PNT140	1 068	PNT14045	1 288	PNRD140	1789	PNRD140P	735	PNO140	516	PNKO140	240	
150	PNT150	1 120	PNT15045	1 349	PNRD150	1854	PNRD150P	768	PNO150	549	PNKO150	244	
160	PNT160	1 196	PNT16045	1 441	PNRD160	1947	PNRD160P	800	PNO160	615	PNKO160	246	
180	PNT180	1 346	PNT18045	1 624	PNRD180	2097	PNRD180P	862	PNO180	689	PNKO180	250	
200	PNT200	1 498	PNT20045	1 806	PNRD200	2209	PNRD200P	928	PNO200	755	PNKO200	257	
220	PNT220	1 740	PNT22045	2 101	PNRD220	2730			PNO220	833	PNKO220	263	
250	PNT250	2 100	PNT25045	2 542	PNRD250	3074			PNO250	985	PNKO250	276	
280	PNT280	2 317	PNT28045	2 803	PNRD280	3528			PNO280	1 081	PNKO280	284	
300	PNT300	2 456	PNT30045	2 971	PNRD300	3721			PNO300	1 177	PNKO300	297	

* Celková cena Kontrolního otvoru = kontr. otvor + požadovaný výrobek (např. trubka).



MEIDINGEROVY HLAVICE

Průměr	80	100	110	120	130	140	150	160	180	200
Kód	PNM080	PNM100	PNM110	PNM120	PNM130	PNM140	PNM150	PNM160	PNM180	PNM200
Cena	546	570	598	629	661	701	718	773	883	992

Po dohodě lze dodat i jiné rozměry podle potřeby zákazníka.

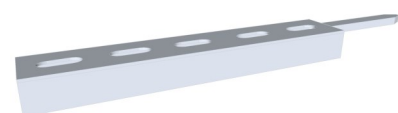

ZATLOUKACÍ KONZOLE - NEREZ

Délka (mm)	250	400
Kód	NKONZ	NKONZV2
Cena	238	285



REDUKCE SE ZPĚTNOU KLAPKOU		
110 / 80	Kód	PNPK11080
	Cena	2 831
125 / 80	Kód	PNPK12580
	Cena	2 950
140 / 80	Kód	PNPK14080
	Cena	3021
160 / 80	Kód	PNPK16080
	Cena	3089
180 / 125	Kód	PNPK180125
	Cena	3364

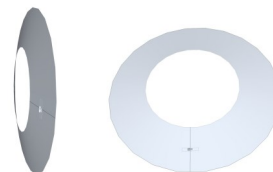

KRYCÍ SUKÝNKY - Nerezové				
Průměr	60	80	100	125
Kód	PNSU060	PNSU080	PNSU100	PNSU125
Cena	227	237	255	266

Lze dodat i jiné rozměry podle potřeby zákazníka.



Redukce rovná



Adaptér rovný



Redukce kónická



Redukce vyťahovaná



Redukce vyosená

REDUKCE A ADAPTÉRY*						
Délka	Redukce rovná		Redukce vyťahovaná		Redukce kónická	
Průměr	Kód	Cena	Kód	Cena	Kód	Cena
80	PNP080	486	PNP080V	245	PNP080K	791
100	PNP100	524	PNP100V	283	PNP100K	839
110	PNP110	546	PNP110V	319	PNP110K	877
120	PNP120	580	PNP120V	338	PNP120K	912
125	PNP125	602	PNP125V	348	PNP125K	943
130	PNP130	627	PNP130V	355	PNP130K	972
140	PNP140	656	PNP140V	388	PNP140K	1 029
150	PNP150	692	PNP150V	409	PNP150K	1 096
160	PNP160	803	PNP160V	444	PNP160K	1 176
180	PNP180	905	PNP180V	499	PNP180K	1 362
200	PNP200	961	PNP200V	602	PNP200K	1 550
220	PNP220	976	PNP220V	705	PNP220K	1 849
250	PNP250	1 250	PNP250V	839	PNP250K	2 365
280	PNP280	1 352	PNP280V	949	PNP280K	2 882
300	PNP300	1 454	PNP300V	1 045	PNP300K	3 221

* Redukce mají hrdlo na velkém průměru, adaptéry na malém. Malý průměr je potřeba udat při objednání. Kód adapt. + AD



SPOJKY hrdlo - hrdlo											
Průměr	80	100	110	120	125	130	140	150	160	180	200
Kód	PNS080	PNS100	PNS110	PNS120	PNS125	PNS130	PNS140	PNS150	PNS160	PNS180	PNS200
Cena	303	316	415	437	451	468	501	535	568	633	699

Plast / obal Al lakovaný



TRUBKY 60 / 100

Délka	Kód	Cena
250	PP60/100R250	418
500	PP60/100R500	466
1 000	PP60/100R1000	601
2 000	PA020T	1830



TRUBKY 80 / 125

Délka	Kód	Cena
250	PP80/125R250	534
500	PP80/125R500	640
1 000	PP80/125R1000	1008
2 000	PA020E	1 856



KOLENA 87°

Průměr	Kód	Cena
60 / 100	PP60/100B90	485
80 / 125	PP80/125B90	831



REVIZNÍ DÍLY

Průměr	Kód	Cena
60 / 100	PP60/100RS	1 238
80 / 125	PP80/125RS	1868



KOLENA 45°

Průměr	Kód	Cena
60 / 100	PP60/100B45	509
80 / 125	PP80/125B45	728



MĚŘÍCÍ DÍLY

Průměr	Kód	Cena
60 / 100	PP60/100R250VM	655
80 / 125	PP80/125R250VM	746



KOLENA 87° REVIZNÍ

Průměr	Kód	Cena
60 / 100	PP60/100RB	1 140
80 / 125	PP80/125RB	1 444

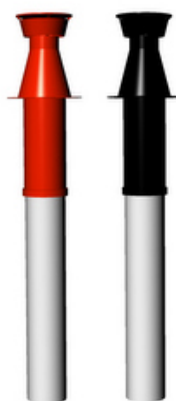

KOMÍNKY VERTIKÁLNÍ

Délka	Kód	Cena
Červené		
60 / 100	PP60/100DDBR	2056
80 / 125	PP80/125DDBR	2056
Černé		
60 / 100	PP60/100DDBS	2056
80 / 125	PP80/125DDBS	2056



KOLENA 87° REVIZNÍ

Průměr	Kód	Cena
60 / 100	PA093TD	1 147
80 / 125	PA093ED	1 606

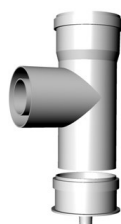

T KUSY REVIZNÍ

S ODKAPEM

Průměr	Kód	Cena
60 / 100	PP60/100TO	2235
80 / 125	PP80/125TO	2770

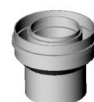

ADAPTÉR

Průměr	Kód	Cena
60 / 100 // 80 / 125	3.012085	474



ODVODY KONDENZÁTU

Průměr	Kód	Cena
60 / 100	PP60/100KA200	837
80 / 125	PP80/125KA200	1598



SILIKONOVÁ PASTA

Obsah	Kód	Cena
150 ml	833SIP	150



ROZDĚLOVAČE		
Průměr	Kód	Cena
60 / 100 // 2 x 80	PA422TTO	820
80 / 125 // 2 x 80	PA422ET	935



OBJÍMKY		
Průměr	Kód	Cena
100	O100	251
125	O125	304



KRYCÍ MANŽETY - NEREZ BÍLÝ		
Použití venkovní i do interiérů		
Průměr	Kód	Cena
80	PNS080B	274
100	PNS100B	291
125	PNS125B	303



KRYCÍ MANŽETY - SILIKON		
Použití do interiérů		
Průměr	Kód	Cena
80	830BG	95
100	830CG	110
125	830DG	278



ROZDĚLOVAČE		
Nerez / nerez bílý		
Průměr	Kód	Cena
60 / 100 // 2 x 80	KROZN6N100	1 188
80 / 125 // 2 x 80	KROZN8N125	1 438



ROZDĚLOVAČE		
Plast / nerez bílý		
Průměr	Kód	Cena
60 / 100 // 2 x 80	KROZP6N100	1 150
80 / 125 // 2 x 80	KROZP8N125	1 392



PŘISÁVACÍ DÍLY		
Průměr	Kód	Cena
60 / 100	PA422TB	866
80 / 125	PA422EB	932



HORIZONTÁLNÍ HLAVICE		
Průměr	Kód	Cena
60 / 100	N890TH	614
80 / 125	N890EH	1012

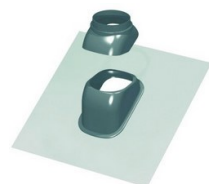

PRŮCHODY STŘECHOU 25 - 50°		
Průměr	Kód	Cena
Červené		
125	ZB125UBPR	976
Černé		
125	ZB125UBPS	976

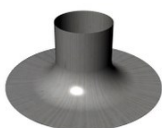

PRŮCHODY STŘECHOU ROVNÉ		
Průměr	Kód	Cena
125	ZB125FDK	661

KOMÍNKY HORIZONTÁLNÍ		
Průměr	Kód	Cena
60 / 100	PP60/100WD	1474
80 / 125	PP80/125WD	1480
60 / 100	PA007TH	688
80 / 125	PA007EH	818
60 / 100	PA10060100	1 372
80 / 125	PA10080125	1 384

Plast / obal Fe lakovaný

TRUBKY					
Délka mm	Průměr	60/100	80/125	100/150	110/160
2015	Kód		PA20080125		
	Cena	1 822			
1015	Kód	PA10060100	PA10080125	PA10100150	PA10110160
	Cena	702	936	1 236	1 440
560	Kód	PA05060100	PA05080125	PA05110160	
	Cena	456	648	852	996
315	Kód	PA02060100	PA02080125	PA02100150	PA02110160
	Cena	414	564	780	828

PŘECHODOVÉ DÍLY					
Průměr	60/100	80/125	100/150	110/160	
Kód	PA01060100IE	PA01080125IE	PA01100150IE	PA1110160IE	
Cena	360	528	648	672	

REDUKCE				
Průměr	80/125	100/150	110/160	
Kód	PA01080125R	PA1100150R	PA01110160R	
Cena	839	1 620	1 668	

ROURY STAVITELNÉ				
Průměr	60/100	80/125	100/150	
Kód	PA05060100S	PA05080125S	PA05100150S	
Cena	1 388	1 597	1 836	

KOLENA					
	Průměr	60/100	80/125	100/150	110/160
87,5°	Kód	PA90060100	PA90080125	PA90100150	PA90110160
	Cena	722	888	1 314	1 392
45°	Kód	PA45060100	PA45080125	PA45100150	PA45110160
	Cena	556	780	1 080	1 146
30°	Kód	PA30060100	PA30080125	PA30100150	PA30110160
	Cena	893	1 077	1 296	1 320
87° revizní	Kód	PA90060100R	PA90080125R	PA90100150R	PA90110160R
	Cena	1 559	1 404	2 160	2 436



HORIZONT. UKONČENÍ					
Průměr	60/100	80/125	100/150	110/160	
Kód	PA10060100H	PA10080125H	PA10100150H	PA10110160H	
Cena	1 361	1 373	2 268	2 280	

T KUSY REVIZNÍ					
	Průměr	60/100	80/125	100/150	110/160
	Kód	PA90060100T	PA90080125T	PA90100150T	PA90110160T
	Cena	1 484	1 344	2 040	2 304
Reduko-	Kód		PA90080125TR	PA90100150TR	PA90110160TR
	Cena		1 752	2 004	2 148



ODVODY KONDENZÁTU					
Průměr	60/100	80/125	100/150	110/160	
Kód	PA90060100O	PA90080125O	PA90100150O	PA90110160O	
Cena	1 292	948	1 278	1 908	

TRUBKY REVIZNÍ 250 mm					
Průměr	60/100	80/125	100/150	110/160	
Kód	PA02060100R	PA02080125R	PA02100150R	PA02110160R	
Cena	1 086	1 523	1 872	2 124	

SVISLÉ UKONČENÍ					
Průměr	60/100	80/125	100/150	110/160	
Černý	Kód	PA10060100VB	PA10080125HVB	PA10100150VB	PA10110160VB
	Cena	1 591	1 691	2 280	2 700
Červený	Kód	PA10060100VR	PA10080125HVR	PA10100150VR	PA10110160VR
	Cena	1 591	1 691	2 280	2 700

Možnost spojování
objímkami



KOAX TRUBKY plast / obal nerez									Pojistné	
	1 m		0,5 m		0,33 m		0,25 m		objímky	
Průměr	Kód	Cena	Kód	Cena	Kód	Cena	Kód	Cena	Kód	Cena
60 / 100	KRP6N100	986	KRP6N1005	606	KRP6N1003	480	KRP6N1002	463	NPO100	206
80 / 125	KRP8N125	1 033	KRP8N1255	684	KRP8N123	515	KRP8N122	472	NPO125	214
100 / 150	KRP10N150	1 437	KRP10N155	837	KRP10N153		KRP10N152	614	NPO150	229
110 / 160	KRP11N160	1 409	KRP11N165	794	KRP11N163		KRP11N162	622	NPO160	230
125 / 175	KRP12N17	1 660	KRP12N175	1 008	KRP12N173		KRP12N172	737	NPO170	235
160 / 210	KRP16N210	2 071	KRP16N215	1 330	KRP16N213		KRP16N212	779	NPO210	262
200 / 280	KRP20N280	3 971	KRP20N285	2 521	KRP20N283		KRP20N282	1 619	NPO280	320



KOAX TRUBKY plast / obal nerez								
	90°		45°		90° revizní		patní	
Průměr	Kód	Cena	Kód	Cena	Kód	Cena	Kód	Cena
60 / 100	KKP6N10	865	KKP60N104	844	KKP60N10K	1 906		
80 / 125	KKP80N12	749	KKP80N124	595	KKP80N12K	1 962	KKP80N12P	913
100 / 150	KKP10N150	923	KKP10N154	943	KKP10N15K	2 391	KKP10N15P	1 084
110 / 160	KKP11N160	924	KKP11N164	735	KKP11N16K	2 122	KKP11N16P	1 085
125 / 175	KKP12N17	1 285	KKP12N174	1 098	KKP12N17K	3 108	KKP12N17P	1 455
160 / 210	KKP16N210	1 598	KKP16N214	1 388	KKP16N21K	3 527	KKP16N21P	1 778
200 / 280	KKP20N280	4 366	KKP20N284	4 553	KKP20N28K	5 305	KKP20N28P	4 546



REDUKCE		
Průměr	Kód	Cena
60 / 100 // 80 / 125	KPP80N125	601
100 / 150 // 80 / 125	KPP10N155	1 550
110 / 160 // 80 / 125	KPP11N165	1 730

OBJÍMKY NA KOTEL		
Průměr	Kód	Cena
100	ON100	253
125	ON125	306

KOTVÍCÍ PRVKY

Typy a ceny na
stranách 36 - 38.



KOAX plast / obal nerez

Průměr	T KUSY		REVIZNÍ DÍLY		ODKAPY DVOJITÉ		PŘISÁVACÍ DÍLY		PŘISÁVACÍ DÍLY REVIZNÍ	
	Kód	Cena	Kód	Cena	Kód	Cena	Kód	Cena	Kód	Cena
60 / 100	KTP6N10	1 261	KRDP6N10	1 304	KOP6N10	905	KPD6N10	1 066	KPDRP6N10	1 945
80 / 125	KTP8N125	1 310	KRDP8N1255	1 395	KOP8N125	919	KPDP8N12	1 109	KPDRP8N12	2 087
100 / 150	KTP10N150	2 317	KRDP10N155	2 002	KOP10N150	1 117	KPDP10N15	1 230	KPDRP10N15	2 289
110 / 160	KTP11N160	2 157	KRDP11N165	1 429	KOP11N160	990	KPDP11N16	1 231	KPDRP11N16	2 776
125 / 175	KTP12N175	3 896	KRDP12N175	2 152	KOP12N175	1 588	KPDP12N17	1 331	KPDRP12N17	3 408
160 / 210	KTP16N210	5 225	KRDP16N215	3 727	KOP16N210	1 902	KPDP16N21	1 371	KPDRP16N21	4 657
200 / 280	KTP20N280	7 564	KRDP20N285	4 081	KOP20N280	2 558	KPDP20N28	1 994	KPDRP20N28	4 756

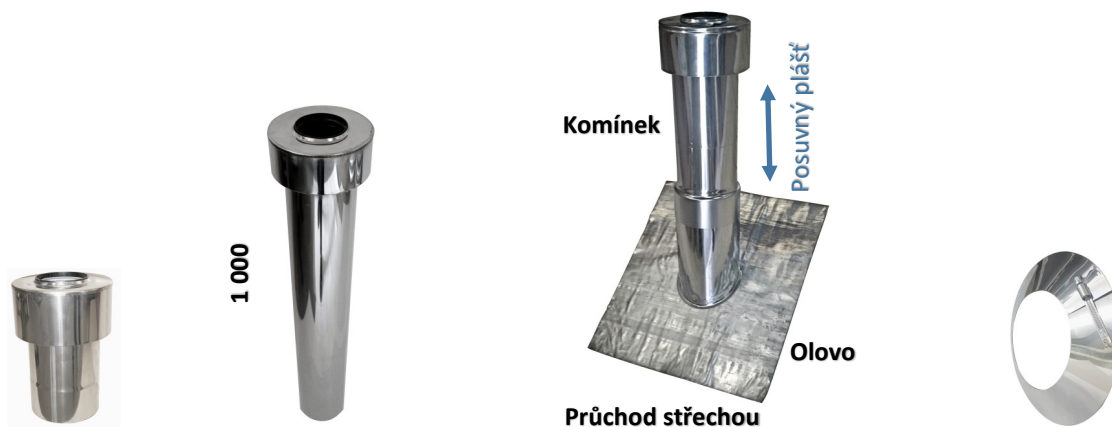

KOAX plast / obal nerez

Průměr	HORNÍ USLEPENÍ S PŘISÁVÁNÍM		KOMÍNEK PEVNÝ		KOMÍNEK POSUVNÝ		PRŮCHOD STŘECHOU		SUKÝNKY	
	Kód	Cena	Kód	Cena	Kód	Cena	Kód	Cena	Kód	Cena
60 / 100	KHUPP6N10	1 087	KKOMP6N10	1 636	KKOMP6N10P	2 000	KPS100	1 757	PNSU100	257
80 / 125	KHUPP8N12	1 109	KKOMP8N12	1 683	KKOMP8N1P	2 057	KPS125	1 786	PNSU125	268
100 / 150	KHUPP10N15	1 230	KKOMP10N15	1 998	KKOMP10N1P	2 966	KPS150	1 976	PNSU150	289
110 / 160	KHUPP11N16	1 231	KKOMP11N16	1 998	KKOMP11N1P	3 001	KPS160	2 112	PNSU160	292
125 / 175	KHUPP12N17	1 331	KKOMP12N17	2 178	KKOMP12N1P	3 643	KPS175	2 423	PNSU175	294
160 / 210	KHUPP16N21	1 371	KKOMP16N21	2 481	KKOMP16N2P	5 680	KPS210	3 275	PNSU210	300
200 / 280	KHUPP20N28	1 994	KKOMP20N28	3 865	KKOMP20N2P	6 390	KPS280	4 286	PNSU280	372



HADICE BemAk, BemAl				
Průměr	Nerez 0,3 mm		Hliník 0,5 mm	
	Kód	Cena / 1m	Kód	Cena / 1m
125	BNH125	548	HH125	361
130	BNH130	562	HH130	370

Po dohodě lze dodat i jiné rozměry podle potřeby zákazníka.



KOAX ohebná sestava

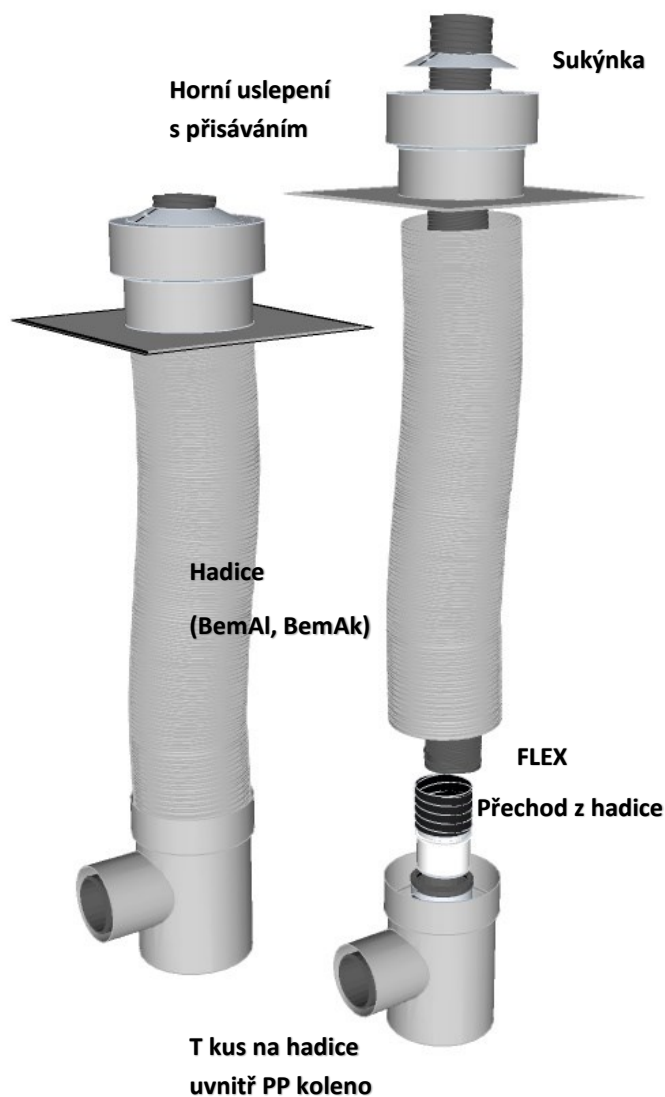

T KUSY PRO OHEBNÉ SESTAVY				
Průměr	S PP kolenem		Bez PP kolena	
	Kód	Cena	Kód	Cena
80 / 125	KTKP8N125	1 271	KT8N125	1044
80 / 130 // 125	KTKP8N130	1 271	KT8N130	1044

Po dohodě lze dodat i jiné rozměry podle potřeby zákazníka.



HORNÍ USLEPENÍ S PŘISÁVÁNÍM				
Průměr	Bez plechu		S plechem	
	Kód	Cena	Kód	Cena
60 / 100	NHUSP100	686	NHUSP100P	1 023
80 / 125	NHUSP125	851	NHUSP125P	1 135
80 / 130	NHUSP130	867	NHUSP130P	1 142
80 / 150	NHUSP150	884	NHUSP150P	1 254
80 / 160	NHUSP160	1 294	NHUSP160P	1 478
80 / 180	NHUSP180	1 386	NHUSP180P	1 650
80 / 200	NHUSP200	1 428	NHUSP200P	1 709

Možnost spojování

objímkami



KOAX TRUBKY nerez / obal nerez									Pojistné	
	1 m		0,5 m		0,33 m		0,25 m		objímky	
Průměr	Kód	Cena	Kód	Cena	Kód	Cena	Kód	Cena	Kód	Cena
60 / 100	KRN60N10	1 484	KRN60N105	1 002	KRN60N103	735	KRN60N102	587	NPO100	206
80 / 125	KRN80N12	1 361	KRN80N125	855	KRN80N123	622	KRN80N122	512	NPO125	214
100 / 150	KRN10N150	1 559	KRN10N155	934	KRN10N153	716	KRN10N152	591	NPO150	229
110 / 160	KRN11N160	1 652	KRN11N165	1 042	KRN11N163	787	KRN11N162	648	NPO160	230
125 / 175	KRN12N17	1 819	KRN12N175	1 152	KRN12N173	920	KRN12N172	699	NPO170	235
130 / 180	KRN13N180	1 857	KRN13N185	1 177	KRN13N183	944	KRN13N182	717	NPO180	237
150 / 200	KRN15N200	2 060	KRN15N205	1 313	KRN15N203	963	KRN15N202	807	NPO200	248
160 / 210	KRN16N210	2 155	KRN16N215	1 376	KRN16N213	1 014	KRN16N212	847	NPO210	262
180 / 230	KRN18N230	2 325	KRN18N235	1 560	KRN18N233	1 155	KRN18N232	955	NPO230	266
200 / 280	KRN20N280	2 660	KRN20N285	1 705	KRN20N283	1 261	KRN20N282	1 051	NPO280	320

Po dohodě lze dodat i jiné rozměry podle potřeby zákazníka.

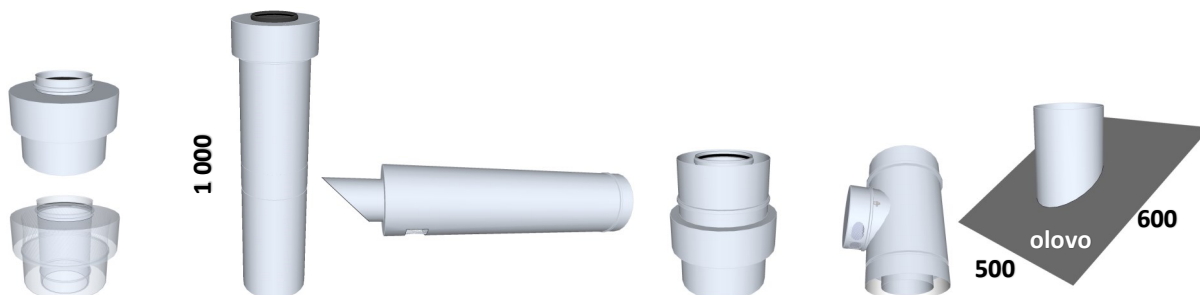

Průměr	HORNÍ		KOMÍNKY		KOMÍNKY		PŘISÁVACÍ DÍLY		PŘISÁVACÍ DÍLY		PRŮCHODY	
	UKONČENÍ		POSUVNÉ		HORIZONTÁLNÍ		PRŮBĚŽNÉ		REVIZNÍ		STŘECHOU	
	Kód	Cena	Kód	Cena	Kód	Cena	Kód	Cena	Kód	Cena	Kód	Cena
60 / 100	KHUPN6N10	902	KKOMN6N10P	2 255	KKOMN6N10H	2 255	KPDN6N10	902	KPDRN6N10	2 174	KPS100	1 757
80 / 125	KHUPN8N12	924	KKOMN8N12P	2 104	KKOMN8N12H	2 104	KPDN8N12	924	KPDRN8N12	2 264	KPS125	1 786
100 / 150	KHUPN10N15	1 000	KKOMN10N1P	2 955	KKOMN10N1H	2 955	KPDN10N15	1 000	KPDRN10N15	2 495	KPS150	1 976
110 / 160	KHUPN11N16	1 057	KKOMN11N1P	3 094	KKOMN11N1H	3 094	KPDN11N16	1 057	KPDRN11N16	2 508	KPS160	2 112
125 / 175	KHUPN12N17	1 124	KKOMN12N1P	3 373	KKOMN12N1H	3 373	KPDN12N17	1 124	KPDRN12N17	2 746	KPS175	2 423
130 / 180	KHUPN13N18	1 153	KKOMN13N1P	3 475	KKOMN13N1H	3 475	KPDN13N18	1 153	KPDRN13N18	2 822	KPS180	2 596
150 / 200	KHUPN15N20	1 209	KKOMN15N2P	3 803	KKOMN15N2H	3 803	KPDN15N20	1 209	KPDRN15N20	3 167	KPS200	3 114
160 / 210	KHUPN16N21	1 306	KKOMN16N2P	4 004	KKOMN16N2H	4 004	KPDN16N21	1 273	KPDRN16N21	3 405	KPS210	3 275
180 / 230	KHUPN18N23	1 421	KKOMN18N2P	4 393	KKOMN18N2H	4 393	KPDN18N23	1 421	KPDRN18N23	3 963	KPS230	3 499
200 / 280	KHUPN20N28	1 513	KKOMN20N2P	4 958	KKOMN20N2H	4 958	KPDN20N28	1 513	KPDRN20N28	4 494	KPS280	4 286

Po dohodě lze dodat i jiné rozměry podle potřeby zákazníka.



KOAX KOLENA nerez / obal nerez										
	90°		45°		90° revizní		patní		s přísáváním	
Průměr	Kód	Cena	Kód	Cena	Kód	Cena	Kód	Cena	Kód	Cena
60 / 100	KKN60N100	1 614	KKN60N104	1 218	KKN60N10K	2 319	KKN60N10P	1 541	KKN6N10PS	1 836
80 / 125	KKN80N125	1 241	KKN80N124	915	KKN80N12K	2 233	KKN80N12P	1 394	KKN8N12PS	1 687
100 / 150	KKN10N150	1 401	KKN10N154	1 000	KKN10N15K	2 495	KKN10N15P	1 554	KKN10N1PS	2 090
110 / 160	KKN11N160	1 471	KKN11N164	1 086	KKN11N16K	2 696	KKN11N16P	1 631	KKN11N1PS	2 162
125 / 175	KKN12N175	1 636	KKN12N174	1 186	KKN12N17K	2 966	KKN12N17P	1 806	KKN12N1PS	2 413
130 / 180	KKN13N180	1 674	KKN13N184	1 203	KKN13N18K	3 013	KKN13N18P	1 845	KKN13N1PS	2 556
150 / 200	KKN15N200	1 895	KKN15N204	1 394	KKN15N20K	3 484	KKN15N20P	2 067	KKN15N2PS	2 851
160 / 210	KKN16N210	2 013	KKN16N214	1 485	KKN16N21K	3 709	KKN16N21P	2 224	KKN16N2PS	3 066
180 / 230	KKN18N230	2 232	KKN18N234	1 661	KKN18N23K	3 929	KKN18N23P	2 444	KKN18N2PS	3 410
200 / 280	KKN20N280	3 034	KKN20N284	2 151	KKN20N28K	4 989	KKN20N28P	3 225	KKN20N2PS	3 849



	T KUSY		REVIZNÍ DÍLY		ZACHYTÁVAČE		ODKAPY	
Průměr	Kód	Cena	Kód	Cena	Kód	Cena	Kód	Cena
60 / 100					KZKN6N100	1 128	KON60N100	735
80 / 125	KTN80N125	1 437	KRDN80N125	2 132	KZKN8N125	1 052	KON80N125	623
100 / 150	KTN10N150	1 621	KRDN10N150	2 389	KZKN10N15	1 132	KON10N150	674
110 / 160	KTN11N160	1 667	KRDN11N160	2 654	KZKN11N16	1 189	KON11N160	717
125 / 175	KTN12N175	1 878	KRDN12N175	2 959	KZKN12N17	1 240	KON12N175	779
130 / 180	KTN13N180	1 939	KRDN13N180	3 006	KZKN13N18	1 267	KON13N180	824
150 / 200	KTN15N200	2 206	KRDN15N200	3 416	KZKN15N20	1 368	KON15N200	917
160 / 210	KTN16N210	2 312	KRDN16N210	3 700	KZKN16N21	1 407	KON16N210	1 009
180 / 230	KTN18N230	2 563	KRDN18N230	3 802	KZKN18N23	1 521	KON18N230	1 095
200 / 280	KTN20N280	3 103	KRDN20N280	4 879	KZKN20N28	1 617	KON20N280	1 288

KOTVÍCÍ PRVKY

Typy a ceny na stranách 36 - 38.



	REDUKCE		REDUKCE SE ZACHYTÁVAČEM	
Průměr	Kód	Cena	Kód	Cena
60 / 100 // 80 / 125	KPN80N125	840	KPN80N125Z	2250
100 / 150 // 80 / 125	KPN10N150	1 225	KPN10N150Z	

OBJÍMKY NA KOTEL

Průměr	Kód	Cena
100	ON100	253
125	ON125	306

Kaskády plastové							
	Průměr	110/80	125/80	160/80	160/110	200/80	200/110
2 kotle	Kód	45211080	45212580	45216080	452160110	45220080	452200110
	Cena	8416	9675	11241	14139	15228	18761
3 kotle	Kód	45311080	45312580	45316082	453160110	45320080	453200110
	Cena	12197	13849	16129	20480	21327	26627
4 kotle	Kód	45411080	45412580	45416080	454160110	45420080	454200110
	Cena	15984	18029	21042	26820	27452	34491

Po dohodě lze dodat i jiné rozměry podle potřeby zákazníka.

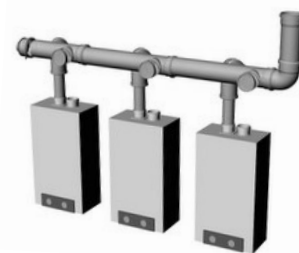

SBĚRAČE S ODBOČKOU 45°					
Průměr	110/110	125/110	160/110	200/80	200/110
Kód	15110110	15125110	15160110	1520080	15200110
Cena	1628	2021	2735	3032	4259

KOLENA	
Průměr	110
Kód	10110T
Cena	188

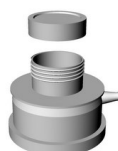

REVIZNÍ VÍČKA S ODVODEM KONDENZÁTU					
Průměr	110	125	160	200	250
Kód	41110	41125	41160	41200T	41250T
Cena	842	1313	1392	3031	3406

SIFON	
Kód	sifon28
Cena	648



ADAPTÉRY SE ZPĚTNOU KLAPKOU		
Průměr	110/80	110/160/110
Kód	4211080	42110160
Cena	2596	3407



ADAPTÉRY	
Průměr	110/80
Kód	3680110
Cena	762

Možnost spojování

objímkami



Kaskády nerezové

	Průměr	110/80	125/80	130/80	140/80	160/80	160/110	200/80	200/110	250/150
2 kotle	Kód	PNK211080	PNK212580	PNK213080	PNK214080	PNK216080	PNK2160110	PNK220080	PNK2200110	PNK2250150
	Cena	10914	11334	11592	11777	12335	14960	13526	16150	20150
3 kotle	Kód	PNK311080	PNK312580	PNK313080	PNK314080	PNK316080	PNK3160110	PNK320080	PNK3200110	PNK3250150
	Cena	16120	16733	17102	17365	18152	22089	19868	23805	29444
4 kotle	Kód	PNK411080	PNK412580	PNK413080	PNK414080	PNK416080	PNK4160110	PNK420080	PNK4200110	PNK4250150
	Cena	21326	21132	22612	22953	23970	29218	26211	31460	38738

Kaskáda obsahuje: T kusy 45°, roury 0,5 m, víčko s odvodem kondenzátu, kolena, adaptéry s klapkou.

Po dohodě lze dodat i jiné rozměry a průměry podle potřeby zákazníka.

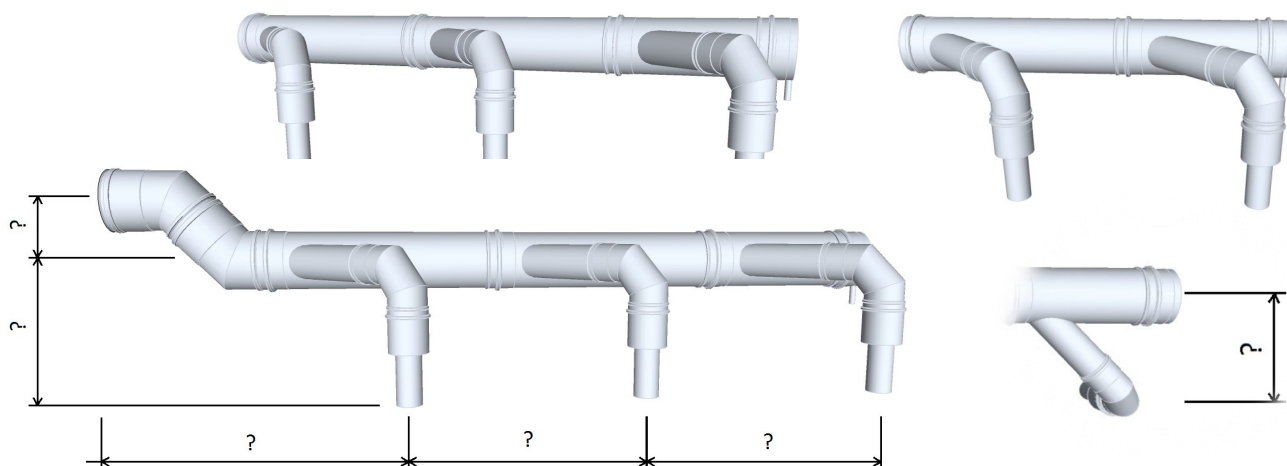

REDUKCE SE ZPĚTNOU KLAPKOU

	Kód	Cena
110 / 80	PNPK11080	2 831
125 / 80	PNPK12580	3 021
140 / 80	PNPK14080	3 364
160 / 80	PNPK16080	3 089
180 / 125	PNPK180125	3 886
200/150	PNPK200150	3 886

POJISTNÉ OBJÍMKY

Průměr	Kód	Cena
110	NPO110	200
120	NPO125	206
130	NPO130	207
140	NPO140	212
160	NPO160	221
200	NPO200	233
250	NPO250	269

Hliníkový plášť může být za příplatek 15 % v těchto odstínech:



TRUBKY plast / izolace / obal hliník

Délka	Průměr	80/130	80/140	100/155	110/165	125/180	160/220	200/280
1 m	Kód	PTRP80H130	PTRP80H140	PTRP10H150	PTRP11H160	PTRP12H180	PTRP16H220	PTRP20H280
	Cena	836	848	1 151	1 150	1 423	1 834	3 578
0,5 m	Kód	PTRP80H135	PTRP80H145	PTRP10H155	PTRP11H165	PTRP12H185	PTRP16H225	PTRP20H285
	Cena	564	574	680	652	872	1 172	2 262
0,3 m	Kód	PTRP80H133	PTRP80H143					
	Cena	465	474					
0,25 m	Kód	PTRP80H132	PTRP80H142	PTRP10H152	PTRP11H162	PTRP12H182	PTRP16H222	PTRP20H282
	Cena	437	413	497	497	668	703	1 462

Po dohodě lze dodat i jiné rozměry podle potřeby zákazníka.



T KUSY, REVIZNÍ DÍLY, ODKAPY plast / izolace / obal hliník

	Průměr	80/130	80/140	100/155	110/165	125/180	160/220	200/280
T kus	Kód	PTTP80H130	PTTP80H140	PTTP10H155	PTTP11H165	PTTP12H180	PTTP16H220	PTTP20H280
	Cena	1 423	1 438	1 913	1 763	2 939	3 949	4 991
Revizní díl	Kód	PTRDP80H13	PTRDP80H14	PTRDP10H15	PTRDP11H16	PTRDP12H18	PTRDP16H22	PTRDP20H28
	Cena	1 273	1 284	1 372	1 276	2 328	3 501	3 942
Odkap dvojitý	Kód	PTODP80H13	PTODP80H14	PTODP10H15	PTODP11H16	PTODP12H18	PTODP16H22	PTODP20H28
	Cena	749	752	851	854	1 349	1 634	2 235

Po dohodě lze dodat i jiné rozměry podle potřeby zákazníka.



UKONČENÍ plast / izolace / obal hliník

	Průměr	80/130	80/140	100/155	110/165	125/180	160/220	200/280
Horní uslepení rovné	Kód	PHU130	PHU140	PHU155	PHU165	PHU180	PHU220	PHU280
	Cena	172	172	194	224	235	379	454
Horní uslepení kónické	Kód	PTHUP80H13	PTHUP80H14	PTHUP10H15	PTHUP11H16	PTHUP12H18	PTHUP16H22	PTHUP20H28
	Cena	875	891	997	1 025	1 079	1 199	1 662
Dolní uslepení	Kód	PDU130	PDU140	PDU155	PDU165	PDU180	PDU220	PDU280
	Cena	172	172	194	224	235	379	454

Po dohodě lze dodat i jiné rozměry podle potřeby zákazníka.



Koleno 90°



Koleno 45°



Koleno revizní



Koleno patní

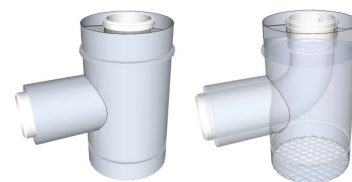

Koleno se sítkou

KOLENA plast / izolace / obal hliník

	Průměr	80/130	80/140	100/155	110/165	125/180	160/220	200/280
90°	Kód	PTKP80H130	PTKP80H140	PTKP10H150	PTKP11H160	PTKP12H180	PTKP16H220	PTKP20H280
	Cena	558	585	1 411	1 386	1 795	2 341	5 510
45°	Kód	PTKP80H134	PTKP80H144	PTKP10H154	PTKP11H164	PTKP12H184	PTKP16H224	PTKP20H284
	Cena	481	498	783	638	908	1 165	4 553
Revizní 90°	Kód	PTKP80H13K	PTKP80H14K	PTKP10H15K	PTKP11H16K	PTKP12H18K	PTKP16H22K	PTKP20H28K
	Cena	1 586	1 613	1 772	1 857	3 141	3 838	6 493
90° patní	Kód	PTKP80H13P	PTKP80H14P	PTKP10H15P	PTKP11H16P	PTKP12H18P	PTKP16H22P	PTKP20H28P
	Cena	822	834	1 612	1 592	2 022	2 682	5 905
Patní se sítkou	Kód	PTKP80H13S	PTKP80H14S	PTKP10H15S	PTKP11H16S	PTKP12H18S	PTKP16H22S	PTKP20H28S
	Vývod	80/125	80/125	Podle potřeby	Podle potřeby	Podle potřeby	Podle potřeby	Podle potřeby
	Cena	1 052	1 064	1 777	1 583	2 008	2 269	4 247

Po dohodě lze dodat i jiné rozměry podle potřeby zákazníka.

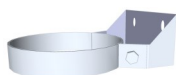

Kotva



Spona



Spona s maticí



Spona s kombivrutem



Konzole

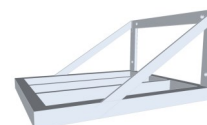

Konzole nosná

KOTVÍCÍ PRVKY

Typy a ceny na stranách 36 - 38.

Možnost spojování

objímkami



Plášť může být z leštěného
nebo neleštěného nerez.



TRUBKY plast / izolace / obal nerez

Délka	Průměr	80/130	80/140	100/155	110/165	125/180	160/220	200/280
1 m	Kód	PTRP80N130	PTRP80N140	PTRP10N150	PTRP11N160	PTRP12N180	PTRP16N220	PTRP20N280
	Cena	1 310	1 377	1 749	1 703	1 956	2 416	4 378
0,5 m	Kód	PTRP80N135	PTRP80N145	PTRP10N155	PTRP11N165	PTRP12N185	PTRP16N225	PTRP20N285
	Cena	877	914	1 033	996	1 206	1 551	2 774
0,3 m	Kód	PTRP80N133	PTRP80N143					
	Cena	664	688					
0,25 m	Kód	PTRP80N132	PTRP80N142	PTRP10N152	PTRP11N162	PTRP12N182	PTRP16N222	PTRP20N282
	Cena	598	618	743	751	886	945	1 791

Po dohodě lze dodat i jiné rozměry podle potřeby zákazníka.



T KUSY, REVIZNÍ DÍLY, ODKAPY plast / izolace / obal nerez

	Průměr	80/130	80/140	100/155	110/165	125/180	160/220	200/280
T kus	Kód	PTTP80N130	PTTP80N140	PTTP10N155	PTTP11N165	PTTP12N180	PTTP16N220	PTTP20N280
	Cena	1 585	1 603	2 560	2 396	4 147	5 533	7 964
Revizní díl	Kód	PTRDP80N13	PTRDP80N14	PTRDP10N15	PTRDP11N16	PTRDP12N18	PTRDP16N22	PTRDP20N28
	Cena	1 431	1 453	2 155	1 766	2 317	3 727	4 321
Odkap dvojitý	Kód	PTODP80N13	PTODP80N14	PTODP10N15	PTODP11N16	PTODP12N18	PTODP16N22	PTODP20N28
	Cena	919	927	1 117	990	1 588	1 902	2 558

Po dohodě lze dodat i jiné rozměry podle potřeby zákazníka.

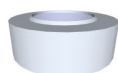

PP UV stabilní



UKONČENÍ plast / izolace / obal nerez

	Průměr	80/130	80/140	100/155	110/165	125/180	160/220	200/280
Horní uslepení rovné	Kód	PNHU130	PNHU140	PNHU155	PNHU165	PNHU180	PNHU220	PNHU280
	Cena	201	216	220	232	255	318	392
Horní uslepení kónické	Kód	PTHUP80N13	PTHUP80N14	PTHUP10N15	PTHUP11N16	PTHUP12N18	PTHUP16N22	PTHUP20N28
	Cena	1 018	1 053	1 096	1 130	1 284	1 393	1 995
Dolní uslepení	Kód	PNDU130	PNDU140	PNDU155	PNDU165	PNDU180	PNDU220	PNDU280
	Cena	201	216	220	232	255	318	392

Po dohodě lze dodat i jiné rozměry podle potřeby zákazníka.



Koleno 90°



Koleno 45°



Koleno revizní



Koleno patní

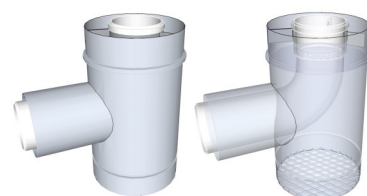

Koleno se sítkou

KOLENA plast / izolace / obal nerez								
	Průměr	80/130	80/140	100/155	110/165	125/180	160/220	200/280
90°	Kód	PTKP80N30	PTKP80N140	PTKP10N150	PTKP11N160	PTKP12N180	PTKP16N220	PTKP20N280
	Cena	860	897	1 679	1 630	2 138	2 881	6 049
45°	Kód	PTKP80N134	PTKP80N144	PTKP10N154	PTKP11N164	PTKP12N184	PTKP16N224	PTKP20N284
	Cena	697	723	1 070	864	1 256	1 563	4 763
Revizní 90°	Kód	PTKP80N13K	PTKP80N14K	PTKP10N15K	PTKP11N16K	PTKP12N18K	PTKP16N22K	PTKP20N28K
	Cena	2 085	2 157	2 564	2 289	3 711	3 766	7 378
90° patní	Kód	PTKP80N13P	PTKP80N14P	PTKP10N15P	PTKP11N16P	PTKP12N18P	PTKP16N22P	PTKP20N28P
	Cena	1 036	1 071	1 878	1 839	2 457	3 220	6 426
Patní se sítkou	Kód	PTKP80N13S	PTKP80N14S	PTKP10N15S	PTKP11N16S	PTKP12N18S	PTKP16N22S	PTKP20N28S
	Vývod	80/125	80/125	Podle potřeby	Podle potřeby	Podle potřeby	Podle potřeby	Podle potřeby
	Cena	1 256	1 289	2 038	1 982	2 470	3 044	6 365
Po dohodě lze dodat i jiné rozměry podle potřeby zákazníka.								

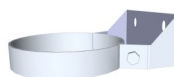

Kotva



Spona



Spona s maticí

POJISTNÉ OBJÍMKY		
Průměr	Kód	Cena
130	NPO130	188
140	NPO140	191
155	NPO155	195
165	NPO165	200
180	NPO180	206
220	NPO220	228
280	NPO280	274

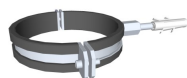

Spona s kombivrutem

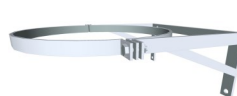

Konzole

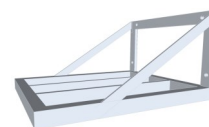

Konzole nosná

KOTVÍCÍ PRVKY

Typy a ceny na stranách 36 - 38.

Přetlakové systémy třísložkové Nerez ČSN EN 1.4404 0,6 mm—T250 P1 O W1

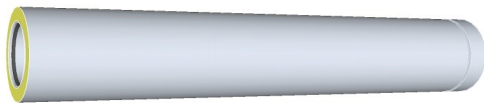

RAL 9010
bílá

RAL 3016
cihlová

RAL 8011
sv. hnědá

RAL 8017
palisandr

RAL 7016
antracit

RAL 9005
černá

Hliníkový plášť může být za příplatek 15 % v těchto odstínech

TRUBKY nerez / izolace / obal hliník

Délka	Průměr	80/130	80/140	100/150	110/160	125/175	130/180	160/210	180/230	200/250	250/300
1 m	Kód	PTRN80H140	PTRN80H140	PTRN10H150	PTRN11H160	PTRN12H170	PTRN13H180	PTRN16H210	PTRN18H230	PTRN20H250	PTRN25H300
	Cena	1 267	1 297	1 496	1 565	1 712	1 761	2 053	2 340	2 648	3 167
0,5 m	Kód	PTRN80H145	PTRN80H145	PTRN10H155	PTRN11H165	PTRN12H175	PTRN13H185	PTRN16H215	PTRN18H235	PTRN20H250	PTRN25H305
	Cena	664	826	933	990	1 063	1 153	1 293	1 616	1 662	2 048
0,3 m	Kód	PTRN80H143	PTRN80H143	PTRN10H153	PTRN11H163	PTRN12H173	PTRN13H183	PTRN16H213	PTRN18H233	PTRN20H253	PTRN25H303
	Cena	558	571	671	734	769	824	931	1 222	1 234	1 547
0,25 m	Kód	PTRN80H142	PTRN80H142	PTRN10H152	PTRN11H162	PTRN12H172	PTRN13H182	PTRN16H212	PTRN18H232	PTRN20H252	PTRN25H302
	Cena	505	513	549	574	634	752	769	976	1 032	1 306

Po dohodě lze dodat i jiné rozměry podle potřeby zákazníka.

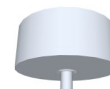

T KUSY, REVIZNÍ DÍLY, ODKAPY nerez / izolace / obal hliník

	Průměr	80/130	80/140	100/150	110/160	125/175	130/180	160/210	180/230	200/250	250/300
T kus	Kód	PTTN80H130	PTTN80H140	PTTN10H150	PTTN11H160	PTTN12H170	PTTN13H180	PTTN16H220	PTTN18H230	PTTN20H250	PTTN25H300
	Cena	1 526	1 547	1 628	1 779	1 947	2 072	2 274	2 644	2 926	4 021
Revizní díly	Kód	PTRDN80H13	PTRDN80H14	PTRDN10H15	PTRDN11H16	PTRDN12H17	PTRDN13H18	PTRDN16H22	PTRDN18H23	PTRDN20H25	PTRDN25H30
	Cena	2 149	2 195	2 365	2 587	2 787	2 880	3 286	3 674	4 301	5 382
Odkapy dvojité	Kód	PTODN80H13	PTODN80H14	PTODN10H15	PTODN11H16	PTODN12H17	PTODN13H18	PTODN16H21	PTODN18H23	PTODN20H25	PTODN25H30
	Cena	491	502	583	634	683	733	901	1 022	1 294	1 524

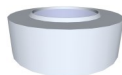

UKONČENÍ nerez / izolace / obal hliník

	Průměr	80/130	80/140	100/150	110/160	125/175	130/180	160/210	180/230	200/250	250/300
Horní uslepení rovné	Kód	PHU130	PHU140	PHU150	PHU160	PHU175	PHU180	PHU210	PHU230	PHU250	PHU300
	Cena	122	122	134	154	161	163	191	271	285	425
Horní uslepení kónické	Kód	PTHUN80H13	PTHUN80H14	PTHUN10H15	PTHUN11H16	PTHUN12H17	PTHUN13H18	PTHUN16H21	PTHUN18H23	PTHUN20H25	PTHUN25H30
	Cena	864	882	997	1 042	1 096	1 126	1 214	1 301	1 386	1 648
Dolní uslepení	Kód	PDU130	PDU140	PDU150	PDU160	PDU175	PDU180	PDU210	PDU230	PDU250	PDU300
	Cena	122	122	134	154	161	163	191	271	285	425



Koleno 90°



Koleno 45°



Koleno revizní



Koleno patní

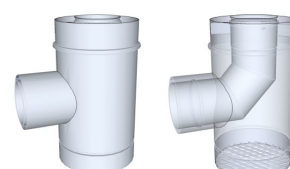

Koleno se sítkou

KOLENA nerez / izolace / obal hliník

	Průměr	80/130	80/140	100/150	110/160	125/175	130/180	160/210	180/230	200/250	250/300
90°	Kód	PTKN80H130	PTKN80H140	PTKN10H150	PTKN11H160	PTKN12H170	PTKN13H180	PTKN16H210	PTKN18H230	PTKN20H250	PTKN25H300
	Cena	1 152	1 177	1 312	1 433	1 572	1 654	1 856	2 263	2 571	3 511
45°	Kód	PTKN80H134	PTKN80H144	PTKN10H154	PTKN11H164	PTKN12H174	PTKN13H184	PTKN16H214	PTKN18H234	PTKN20H254	PTKN25H304
	Cena	914	925	1 007	1 040	1 139	1 230	1 332	1 608	1 785	2 312
Revizní 90°	Kód	PTKN80H13K	PTKN80H14K	PTKN10H15K	PTKN11H16K	PTKN12H17K	PTKN13H18K	PTKN16H21K	PTKN18H23K	PTKN20H25K	PTKN25H30K
	Cena	2 119	2 171	2 421	2 607	2 812	2 952	3 485	3 890	4 717	5 863
90° patní	Kód	PTKN80H13P	PTKN80H14P	PTKN10H15P	PTKN11H16P	PTKN12H17P	PTKN13H18P	PTKN16H21P	PTKN18H23P	PTKN20H25P	PTKN25H30P
	Cena	1 363	1 387	1 491	1 616	1 800	1 903	2 085	2 341	2 839	3 842
Patní se sítkou	Kód	PTKN80H13S	PTKN80H14S	PTKN10H15S	PTKN11H16S	PTKN12H17S	PTKN13H18S	PTKN16H21S	PTKN18H23S	PTKN20H25S	PTKN25H30S
	Cena	1 487	1 506	1 707	1 738	1 905	1 995	2 162	2 699	3 126	3 608

Po dohodě lze dodat i jiné rozměry podle potřeby zákazníka.



Kotva



Spona



Spona s maticí

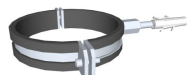

Spona s kombivrutem



Konzole

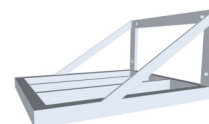

Konzole nosná

KOTVÍCÍ PRVKY

Typy a ceny na stranách 36 - 38.

Možnost spojování

objímkami

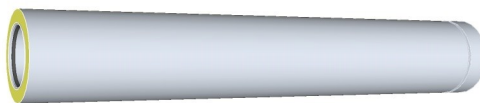

Plášť může být z leštěného
nebo neleštěného nerez.

TRUBKY nerez / izolace / obal nerez

Délka	Průměr	80/130	80/140	100/150	110/160	125/175	130/180	160/210	180/230	200/250	250/300
1 m	Kód	PTRN80N130	PTRN80N140	PTRN10N150	PTRN11N160	PTRN12N170	PTRN13N180	PTRN16N210	PTRN18N230	PTRN20N250	PTRN25N300
	Cena	1 623	1 686	1 834	1 928	2 102	2 163	2 483	2 698	3 044	3 607
0,5 m	Kód	PTRN80N135	PTRN80N145	PTRN10N155	PTRN11N165	PTRN12N175	PTRN13N185	PTRN16N215	PTRN18N235	PTRN20N255	PTRN25N305
	Cena	1 037	1 073	1 120	1 240	1 363	1 383	1 588	1 794	1 939	2 301
0,3 m	Kód	PTRN80N133	PTRN80N143	PTRN10N153	PTRN11N163	PTRN12N173	PTRN13N183	PTRN16N213	PTRN18N233	PTRN20N253	PTRN25N303
	Cena	762	784	860	933	1 082	1 109	1 186	1 339	1 448	1 714
0,25 m	Kód	PTRN80N132	PTRN80N142	PTRN10N152	PTRN11N162	PTRN12N172	PTRN13N182	PTRN16N212	PTRN18N232	PTRN20N252	PTRN25N302
	Cena	631	649	712	771	845	867	1 000	1 121	1 212	1 422

Po dohodě lze dodat i jiné rozměry a průměry podle potřeby zákazníka.

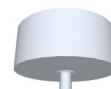
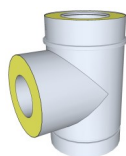

T KUSY, REVIZNÍ DÍLY, ODKAPY nerez / izolace / obal nerez

	Průměr	80/130	80/140	100/150	110/160	125/175	130/180	160/210	180/230	200/250	250/300
T kus	Kód	PTTN80N130	PTTN80N140	PTTN10N150	PTTN11N160	PTTN12N170	PTTN13N180	PTTN16N210	PTTN18N230	PTTN20N250	PTTN25N300
	Cena	1 656	1 698	1 846	1 881	2 119	2 174	2 585	2 936	3 389	4 629
Revizní díly	Kód	PTRDN80N13	PTRDN80N14	PTRDN10N15	PTRDN11N16	PTRDN12N17	PTRDN13N18	PTRDN16N22	PTRDN18N23	PTRDN20N25	PTRDN25N30
	Cena	2 275	2 299	2 559	2 819	3 138	3 174	3 898	4 055	5 119	5 785
Odkapy	Kód	PTODN80N13	PTODN80N14	PTODN10N15	PTODN11N16	PTODN12N17	PTODN13N18	PTODN16N21	PTODN18N23	PTODN20N25	PTODN25N30
	Cena	584	594	674	717	779	784	1 009	1 095	1 288	1 590

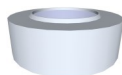

UKONČENÍ nerez / izolace / obal nerez

	Průměr	80/130	80/140	100/150	110/160	125/175	130/180	160/210	180/230	200/250	250/300
Horní uslepení rovné	Kód	PNU130	PNHU140	PNHU150	PNHU160	PNHU175	PNHU180	PNHU210	PNHU230	PNHU250	PNHU300
	Cena	201	216	220	232	249	255	299	343	374	451
Horní uslepení kónické	Kód	PTHUN80N13	PTHUN80N14	PTHUN10N15	PTHUN11N16	PTHUN12N17	PTHUN13N18	PTHUN16N21	PTHUN18N23	PTHUN20N25	PTHUN25N30
	Cena	1 013	1 046	1 164	1 219	1 304	1 329	1 487	1 560	1 672	1 994
Dolní uslepení	Kód	PNDU130	PNDU140	PNDU150	PNDU160	PNDU175	PNDU180	PNDU210	PNDU230	PNDU250	PNDU300
	Cena	201	216	220	232	249	255	299	343	374	451



Koleno 90°



Koleno 45°



Koleno revizní



Koleno patní

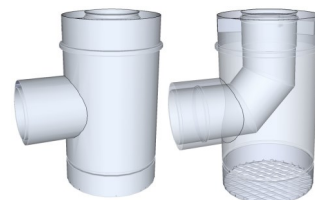

Koleno se sítkou

KOLENA nerez / izolace / obal nerez

	Průměr	80/130	80/140	100/150	110/160	125/175	130/180	160/210	180/230	200/250	250/300
90°	Kód	PTKN80N130	PTKN80N140	PTKN10N150	PTKN11N160	PTKN12N170	PTKN13N180	PTKN16N210	PTKN18N230	PTKN20N250	PTKN25N300
	Cena	1 386	1 418	1 568	1 636	1 815	1 868	2 224	2 484	2 778	4 099
45°	Kód	PTKN80N134	PTKN80N144	PTKN10N154	PTKN11N164	PTKN12N174	PTKN13N184	PTKN16N214	PTKN18N234	PTKN20N254	PTKN25N304
	Cena	1 037	1 056	1 122	1 210	1 339	1 365	1 656	1 859	2 074	2 708
Revizní 90°	Kód	PTKN80N13K	PTKN80N14K	PTKN10N15K	PTKN11N16K	PTKN12N17K	PTKN13N18K	PTKN16N21K	PTKN18N23K	PTKN20N25K	PTKN25N30K
	Cena	2 390	2 460	2 660	2 867	3 145	3 202	3 922	4 181	5 249	6 852
90° patní	Kód	PTKN80N13P	PTKN80N14P	PTKN10N15P	PTKN11N16P	PTKN12N17P	PTKN13N18P	PTKN16N21P	PTKN18N23P	PTKN20N25P	PTKN25N30P
	Cena	1 539	1 570	1 722	1 960	1 986	2 039	2 434	2 695	3 047	4 430
Patní se sítkou	Kód	PTKN80N13S	PTKN80N14S	PTKN10N15S	PTKN11N16S	PTKN12N17S	PTKN13N18S	PTKN16N21S	PTKN18N23S	PTKN20N25S	PTKN25N30S
	Cena	1 712	1 737	1 889	1 969	2 054	2 097	2 660	2 919	3 442	4 283

Po dohodě lze dodat i jiné rozměry podle potřeby zákazníka.

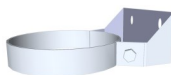

Kotva



Spona



Spona s maticí

POJISTNÉ OBJÍMKY

Průměr	Kód	Cena
130	NPO130	188
140	NPO140	191
155	NPO155	195
165	NPO165	200
180	NPO180	206
220	NPO220	228
280	NPO280	274

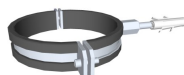

Spona s kombivrutem



Konzole

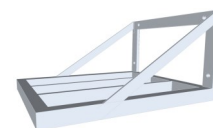

Konzole nosná

KOTVÍCÍ PRVKY

Typy a ceny na stranách 36 - 38.

Kotvící prvky Ocelové, hliníkové a nerezové

Kotvící prvky

Lze vyrobit atypické konzole, spony, držáky, krakorce atd., podle potřeby.

Prvky jsou buď nerezové, nebo ocelové. Nerezové se vyznačují extrémní životností. Ocelové jsou opatřeny vysoce kvalitní komaxitovou barvou, jež může být ve stejném odstínu, jako komínové těleso.

Pro tříšlůžková komínová tělesa doporučujeme použít 1 konzoli na 2 až 3 metry délky komínu.

Při montáži tříšlůžkového komínu na zateplené fasády domů lze použít konzole do zateplení (s trubičkami), jež dosednou skrz izolaci až na zdivo.

Pro nástavce komínů lze použít konzole - stojany, které se kotví do betonové hlavy komínu.

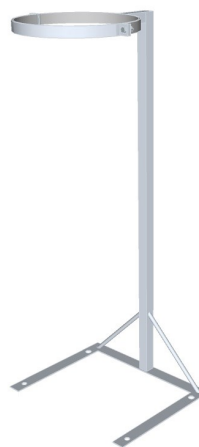

Konzole - stojan



Konzole ATYP

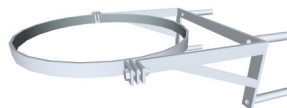

Konzole do zateplení

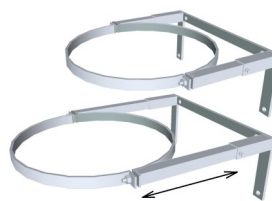

Konzole posuvná



Spony s vrutem nebo maticí

Průměr	Kód	Cena
130	FES130	214
140	FES140	214
150	FES150	214
160	FES160	238
170	FES170	238
180	FES180	238
190	FES190	238
200	FES200	247
210	FES210	247

Po dohodě lze dodat i jiné rozměry podle potřeby zákazníka.

SPONY

Průměr	Hliník		Nerez		
	Kód	Cena	Kód	Cena	
80	HS080	136	NS080	201	Materiál 20x3
100	HS100	144	NS100	209	
110	HS110	152	NS110	224	
120	HS120	176	NS120	230	
125	HS125	176	NS125	235	
130	HS130	176	NS130	240	
140	HS140	176	NS140	260	
150	HS150	177	NS150	329	Materiál 30x3
160	HS160	179	NS160	341	
170	HS170	180	NS170	351	
180	HS180	182	NS180	352	
200	HS200	183	NS200	366	
220			NS220	378	
250			NS250	483	
280			NS280	523	
300			NS300	545	
350			NS350	661	

Po dohodě lze dodat i jiné rozměry podle potřeby zákazníka.

SPONY NA KOMBIVRUT ocelové s gumou

Průměr	Kód	Cena
80	32080	65
100	32100	75
125	32125	90
160	32160	135

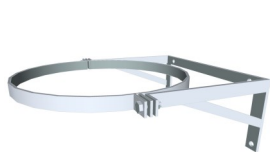

Konzole

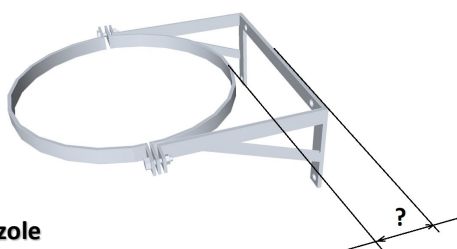

Konzole nosná

Posuvné konzole + 100 Kč

KOTVÍCÍ PRVKY ocelové

Průměr	Konzole 0 - 20 cm		Konzole 20 - 50 cm		Konzole nosné 0 - 20 cm		Konzole nosné 20 - 50 cm	
	Kód	Cena	Kód	Cena	Kód	Cena	Kód	Cena
130	FEK130	588	FEK13025	718	FEKN130	628	FEKN13025	861
140	FEK140	608	FEK14025	745	FEKN140	651	FEKN14025	898
150	FEK150	628	FEK15025	765	FEKN150	674	FEKN15025	926
160	FEK160	651	FEK16025	789	FEKN160	697	FEKN16025	938
170	FEK170	674	FEK17025	810	FEKN170	718	FEKN17025	956
180	FEK180	697	FEK18025	827	FEKN180	741	FEKN18025	978
190	FEK190	718	FEK19025	845	FEKN190	765	FEKN19025	1 002
200	FEK200	741	FEK20025	877	FEKN200	789	FEKN20025	1 024
210	FEK210	745	FEK21025	883	FEKN210	810	FEKN21025	1 045
225	FEK225	751	FEK22525	895	FEKN225	827	FEKN22525	1 075
235	FEK230	757	FEK23025	903	FEKN230	845	FEKN23025	1 090
245	FEK240	760	FEK24025	909	FEKN240	877	FEKN24025	1 113
255	FEK250	765	FEK25025	919	FEKN250	919	FEKN25025	1 134
265	FEK260	775	FEK26025	923	FEKN260	933	FEKN26025	1 157
285	FEK280	781	FEK28025	929	FEKN280	944	FEKN28025	1 180
305	FEK300	789	FEK30025	933	FEKN300	966	FEKN30025	1 202
325	FEK320	799	FEK32025	948	FEKN320	978	FEKN32025	1 214
355	FEK350	810	FEK35025	966	FEKN350	990	FEKN35025	1 225
385	FEK380	845			FEKN380	1 012	FEKN38025	1 248
405	FEK400	861			FEKN400	1 113	FEKN40025	1 277
455	FEK450	877			FEKN450	1 189	FEKN45025	1 309
505	FEK500	910			FEKN500	1 230	FEKN50025	1 329
600	FEK600	933			FEKN600	1 299	FEKN60025	1 358

Po dohodě lze dodat i jiné rozměry podle potřeby zákazníka.

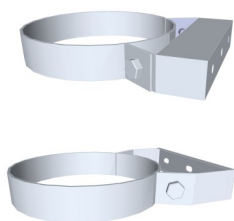

Kotva

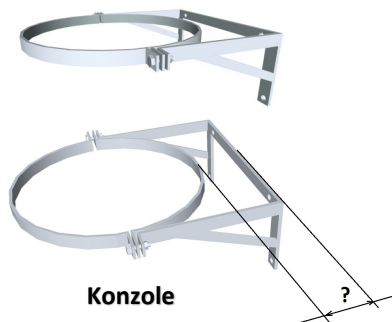

Konzole

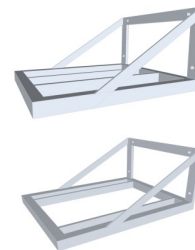

Konzole nosná

Posuvné konzole + 100 Kč

KOTVÍCÍ PRVKY nerezové

Průměr	Kotvy		Konzole 0 - 20 cm		Konzole 20 - 50 cm		Konzole nosné 0 - 20 cm		Konzole nosné 20 - 50 cm	
	Kód	Cena	Kód	Cena	Kód	Cena	Kód	Cena	Kód	Cena
125	NKOT125	623								
130	NKOT130	628	NKS130	927	NKS13025	1 124	NKN130	1 098	NKN13025	1 438
140	NKOT140	636	NKS140	946	NKS14025	1 144	NKN140	1 106	NKN14025	1 448
150	NKOT150	667	NKS150	965	NKS15025	1 163	NKN150	1 115	NKN15025	1 456
160	NKOT160	681	NKS160	983	NKS16025	1 183	NKN160	1 124	NKN16025	1 466
170	NKOT170	733	NKS170	1 003	NKS17025	1 201	NKN170	1 135	NKN17025	1 480
180	NKOT180	787	NKS180	1 021	NKS18025	1 220	NKN180	1 144	NKN18025	1 487
190	NKOT190	793	NKS190	1 040	NKS19025	1 239	NKN190	1 153	NKN190225	1 495
200	NKOT200	802	NKS200	1 059	NKS20025	1 257	NKN200	1 163	NKN20025	1 504
210	NKOT210	817	NKS210	1 068	NKS21025	1 268	NKN210	1 173	NKN21025	1 513
225	NKOT225	832	NKS225	1 079	NKS22525	1 277	NKN225	1 183	NKN22525	1 524
235	NKOT235	842	NKS230	1 088	NKS23025	1 286	NKN230	1 192	NKN23025	1 532
245	NKOT245	865	NKS240	1 098	NKS24025	1 296	NKN240	1 201	NKN24025	1 543
255	NKOT255	889	NKS250	1 106	NKS25025	1 306	NKN250	1 209	NKN25025	1 552
265	NKOT265	930	NKS260	1 115	NKS26025	1 316	NKN260	1 220	NKN26025	1 560
285	NKOT285	979	NKS280	1 135	NKS28025	1 333	NKN280	1 231	NKN28025	1 571
305	NKOT305	1 026	NKS300	1 153	NKS30025	1 354	NKN300	1 239	NKN30025	1 581
325	NKOT325	1 096	NKS320	1 173	NKS32025	1 371	NKN320	1 249	NKN3202525	1 592
355	NKOT355	1 147	NKS350	1 192	NKS35025	1 390	NKN350	1 257	NKN35025	1 602
385			NKS380	1 209	NKS38025	1 412	NKN380	1 268	NKN38025	1 617
405			NKS400	1 231	NKS40025	1 438	NKN400	1 277	NKN40025	1 632
455			NKS450	1 249	NKS45025	1 464	NKN450	1 286	NKN45025	1 649
505			NKS500	1 277	NKS50025	1 500	NKN500	1 296	NKN50025	1 668
600			NKS600	1 306	NKS60025	1 551	NKN600	1 306	NKN60025	1 686

Po dohodě lze dodat i jiné rozměry podle potřeby zákazníka.

Charakteristika podle ČSN EN 14471

Typ systémů	Materiál	Teplotní třída	Tlaková třída	Třída odolnosti při vyhoření sazí	Třída odolnosti proti působení kondenzátu odolnosti proti korozi	Zdálčenost od hořlavých materiálů	Umístění komínu	Reakce na oheň	Třída opláštění
Jednoduché	PP	T120	P1	O	W1	O20	E/I	E	L
	PP	T120	H1	O	W1	O20	E/I	E	L
	Ak	T250	P1	O	W1	O50	E/I	A1	L
Třísložkové	PP	T120	P1	O	W1	O10	E/I	C	L0
	PP	T120	P1	O	W1	O10	E/I	C	L0
	Ak	T250	P1	O	W1	O30	E/I	B	L0
	Ak	T250	P1	O	W1	O30	E/I	B	L0
Koaxiální	PP	T120	P1	O	W1	O10	E/I	E	L1
	PP	T120	H1	O	W1	O10	E/I	E	L0/L1
	Ak	T250	P1	O	W1	O50	E/I	A1	L0/L1
Kaskádové kouřovody	PP	T120	P1	O	W1	O20	I	E	L, L1
	Ak	T250	P1	O	W1	O20	E/I	A1	L, L1, L0
<p>PP – polypropylen Ak nerez 1.4404 0,6 mm</p> <p>Maximální teplota spalin</p> <p>Maximální přetlak spalin P1 - 200 Pa, H1 - 5000Pa</p> <p>G - odolné při vyhoření sazí O - bez odolnosti při vyhoření</p> <p>Kondenzační režim spalin moký úprovoz</p> <p>Vzdálenost od hořlavých před- mětů (mm)</p> <p>E - vnitřní i vnější instalace, I - vnitřní instalace</p> <p>E - vnitřní i vnější instalace</p> <p>L - Bez opláštění L0 - Opláštění oceli, hliníku, nerez L1 - Opláštění plast</p>									

BĚMÁCI s.r.o.
Ukázka další výroby

