

HLINÍKOVÉ KOMPONENTY

Průměr	Trubky *	T kusy S PVC	T kusy	Kolena 90°	Kolena 90° otočná	Kolena 45°	Kolena 45° otočná	Spony	Mei. hlavice	Redukce
70	80			92		70				
80	86			94	109	71	82	55		60
90	93			96	116	72	83	58		62
100	99	172		98	123	73	84	59	68	64
110	105	175		112	135	75	87	59	71	67
120	112	189		115	139	78	89	59	74	70
125	116	200		117	141	82	94	59	76	72
130	120	204		119	142	85	98	59	77	73
140	127	214		127	153	87	102	59	79	76
150	136	235		137	165	95	114	80	81	79
160	138		187	140	98	84	82	82	82	82
170	150		197	144	100	95	85	84	85	84
180	157		214	149	104	102	93	86	93	86
190	165		229	153	107	105	94	90	94	89
200	168		235	157	111	116	95	92	95	92

* - Cena kratší trubky = cena x 1,15 x požadovaná délka

Revizní otvor 150,- Kč + požadovaný výrobek.

Po dohodě lze dodat i jiné rozměry podle potřeby zákazníka.

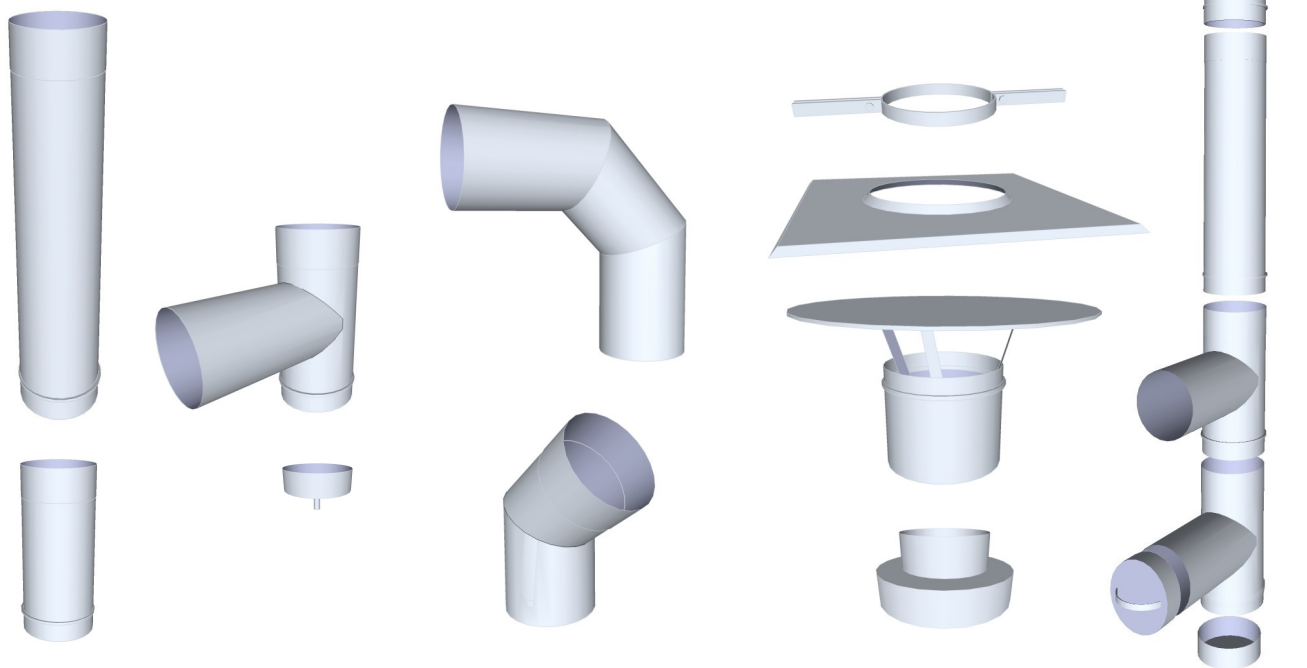

Průměr	Pevné díly									
	Roura 1 m		Roura 0,5 m		Roura 0,33 m		Roura 0,25 m		Revizní otvor *	
	Kód	Cena	Kód	Cena	Kód	Cena	Kód	Cena	Kód	Cena
80	5NR080	225	5NR080A	259	5NR08033	85	5NR08025	65	NKO05	280
90	5NR090	237	5NR090A	273	5NR09033	90	5NR09025	68	NKO05	280
100	5NR00	249	5NR00A	286	5NR10033	95	5NR10025	72	NKO05	280
110	5NKR10	261	5NKR10A	300	5NR11033	99	5NR11025	75	NKO05	280
120	5NKR20	275	5NKR20A	316	5NR12033	105	5NR12025	79	NKO05	280
130	5NR130	290	5NR130A	336	5NR13033	110	5NR13025	84	NKO05	280
140	5NR140	305	5NR140A	351	5NR14033	116	5NR14025	88	NKO05	280
150	5NR150	320	5NR150A	368	5NR15033	121	5NR15025	92	NKO05	280
160	5NR160	335	5NR160A	385	5NR16033	127	5NR16025	96	NKO05	280
180	5NR180	368	5NR180A	423	5NR18033	139	5NR18025	106	NKO05	280
200	5NR200	400	5NR200A	460	5NR20033	152	5NR20025	115	NKO05A	
220	5NR220	432	5NR220A	497	5NR22033	164	5NR22025	124	NKO05A	
250	5NR250	482	5NR250A	554	5NR25033	183	5NR25025	139	NKO05A	
280	5NR280	539	5NR280A	620	5NR28033	204	5NR28025	155	NKO05A	
300	5NR300	577	5NR300A	664	5NR30033	219	5NR30025	166	NKO05A	

* Cena trubky s revizním otvorem = požadovaná délka + revizní otvor

Spojování dílů nýtováním, nebo pojistnými objímkami.

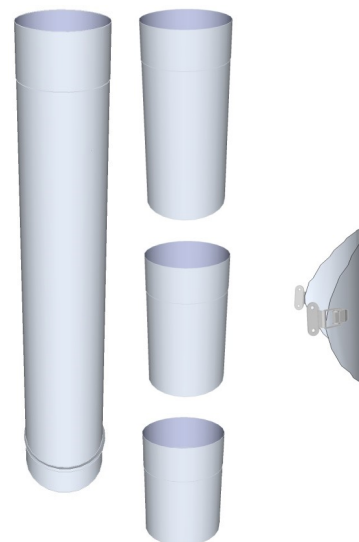

Průměr	Ohebná vložka	
	tl. 0,3 mm	
	Kód	Cena
100	BNH100	393
110	BNH110	393
120	BNH120	414
130	BNH130	446
140	BNH140	490
150	BNH150	524
160	BNH160	562
180	BNH180	627
200	BNH200	696
220	BNH220	801
250	BNH250	986
280	BNH280	1120
300	BNH300	1268

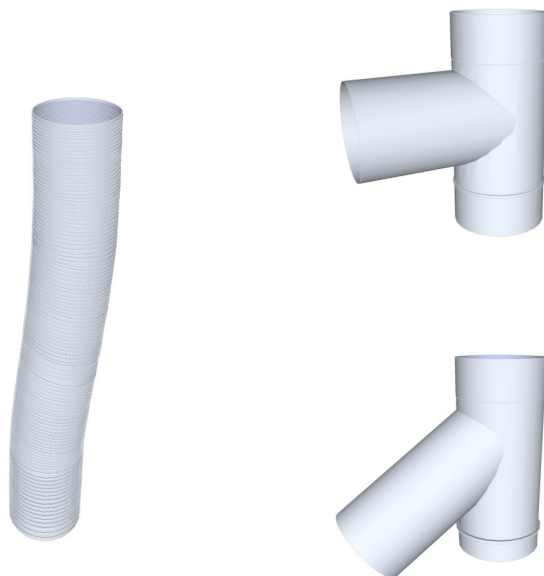

Průměr	T kus 90 °		T kus 45 °	
	Kód	Cena	Kód	Cena
80	5NT080	235	5NT08045	399
90	5NT090	240	5NT09045	408
100	5NT100	245	5NT10045	417
110	5NT110	255	5NT11045	434
120	5NT120	265	5NT12045	450
130	5NT130	275	5NT13045	468
140	5NT140	285	5NT14045	485
150	5NT150	300	5NT15045	510
160	5NT160	320	5NT16045	544
180	5NT180	367	5NT18045	624
200	5NT200	420	5NT20045	714
220	5NT220	480	5NT22045	816
250	5NT250	570	5NT25045	969
280	5NT280	672	5NT28045	1142
300	5NT300	740	5NT30045	1258

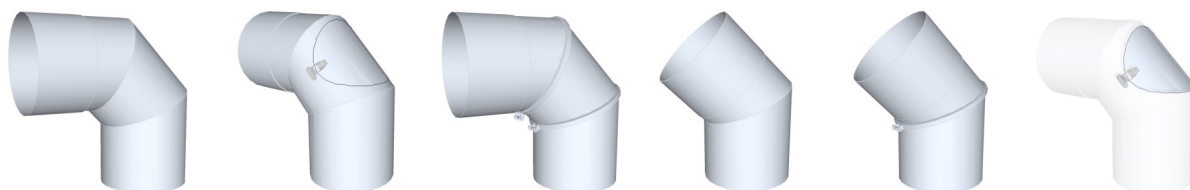

KOLENA												
Průměr	90 °		90 ° s KO		90 ° otočná		45°		45 ° otočná		Kontrolní otvor *	
	Kód	Cena	Kód	Cena	Kód	Cena	Kód	Cena	Kód	Cena	Kód	Cena
80	5NK080	195	5NK080KO	475	5NK080O	234	5NK08045	137	5NK08045O	165	NKO080	280
90	5NK090	205	5NK090KO	485	5NK090O	246	5NK09045	144	5NK09045O	173	NKO090	280
100	5NK100	215	5NK100KO	495	5NK100O	258	5NK10045	151	5NK10045O	181	NKO100	280
110	5NK110	225	5NK110KO	505	5NK110O	270	5NK11045	158	5NK11045O	190	NKO110	280
120	5NK120	235	5NK120KO	515	5NK120O	282	5NK12045	165	5NK12045O	198	NKO120	280
130	5NK130	245	5NK130KO	525	5NK130O	294	5NK13045	172	5NK13045O	207	NKO130	280
140	5NK140	255	5NK140KO	535	5NK140O	306	5NK14045	179	5NK14045O	215	NKO140	280
150	5NK150	267	5NK150KO	547	5NK150O	321	5NK15045	187	5NK15045O	225	NKO150	280
160	5NK160	282	5NK160KO	562	5NK160O	339	5NK16045	197	5NK16045O	237	NKO160	280
180	5NK180	315	5NK180KO	595	5NK180O	378	5NK18045	221	5NK18045O	266	NKO180	280
200	5NK200	355	5NK200KO	635	5NK200O	426	5NK20045	249	5NK20045O	299	NKO200	280
220	5NK220	400	5NK220KO	680			5NK22045	280			NKO220	280
250	5NK250	480	5NK250KO	780			5NK25045	336			NKO250	300
280	5NK280	570	5NK280KO	870			5NK28045	399			NKO280	300
300	5NK300	630	5NK300KO	930			5NK30045	441			NKO300	300

* - Cena kolena s kontrolním otvorem = koleno + kontrolní otvor

Po dohodě lze dodat i jiné rozměry podle potřeby zákazníka.

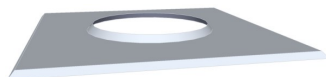

KRYCÍ PLECHY		
Rozměr cm	Kód	Cena
33 X 33	NKP33X33	135
40 x 40	NKP40X40	148
50 x 50	NKP50X50	160

Po dohodě lze dodat i jiné rozměry podle potřeby zákazníka.



KRYCÍ SUKÝNKY					
Průměr	Kód	Cena	Průměr	Kód	Cena
90	NSU090		160	NSU160	
100	NSU100	149	180	NSU180	
110	NSU110		200	NSU200	
120	NSU120		220	NSU220	
130	NSU130		250	NSU250	
140	NSU140		280	NSU280	
150	NSU150		300	NSU300	

Po dohodě lze dodat i jiné rozměry podle potřeby zákazníka,.

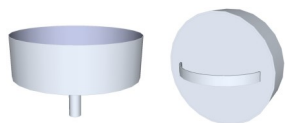

ODKAPY - VÍČKA		
Průměr	Kód	Cena
80	5NO080	91
90	5NO90	93
100	5NO100	95
110	5NO110	97
120	5NO120	101
130	5NO130	105
140	5NO140	109
150	5NO150	115
160	5NO160	120
180	5NO180	133
200	5NO200	148
220	5NO220	166
250	5NO250	193
280	5NO280	220
300	5NO300	238

Po dohodě lze dodat i jiné rozměry podle potřeby zákazníka.

SPONY A OBJÍMKY				
Průměr	Spony		Pojistné objímky	
	Kód	Cena	Kód	Cena
80	NS080	141	NPO080	138
90	NS090	147	NPO090	140
100	NS100	152	NPO100	143
110	NS110	163	NPO110	145
120	NS120	167	NPO120	147
130	NS130	170	NPO130	150
140	NS140	174	NPO140	153
150	NS150	189	NPO150	156
160	NS160	202	NPO160	160
180	NS180	256	NPO180	165
200	NS200	266	NPO200	169
220	NS220	275	NPO220	182
250	NS250	351	NPO250	195
280	NS280	380	NPO280	219
300	NS300	396	NPO300	239

Po dohodě lze dodat i jiné rozměry podle potřeby zákazníka.

Meidingerovy hlavice		
Průměr	Kód	Cena
80	5NM080	135
90	5NM90	146
100	5NM100	135
110	5NM110	139
120	5NM120	144
130	5NM130	150
140	5NM140	156
150	5NM150	164
160	5NM160	172
180	5NM180	190
200	5NM200	212
220	5NM220	237
250	5NM250	275
280	5NM280	314
300	5NM300	340

Po dohodě lze dodat i jiné rozměry podle potřeby zákazníka.

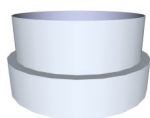

REDUKCE					
Průměr	Kód	Cena	Průměr	Kód	Cena
90	5NP90	132	160	5NP160	172
100	5NP100	135	180	5NP180	190
110	5NP110	139	200	5NP200	212
120	5NP120	144	220	5NP220	237
130	5NP130	150	250	5NP250	275
140	5NP140	156	280	5NP280	314
150	5NP150	164	300	5NP300	340

Po dohodě lze dodat i jiné rozměry podle potřeby zákazníka, také kónické a vyosené provedení.



ZACHYTÁVAČE KONDENZÁTU		
Průměr	Kód	Cena
110	5NZK110	238
120	5NZK120	247
130	5NZK130	255
150	5NZK150	275
180	5NZK180	310
200	5NZK200	350

Po dohodě lze dodat i jiné rozměry podle potřeby zákazníka.